

Sistema de cabezales universales Euro catálogo

con cuchillas de respuesto

UFC 2023



POR QUÉ STEHLE

Stehle - es Fiable

Ya desde hace 100 años Stehle suministra a sus clientes herramientas técnicamente elaboradas - tanto a los aplicadores como al comercio. La empresa Stehle está famosa para cabezales altamente y económicamente precisos para el trabajo de madera dura.

Stehle - un producto de calidad con una clara visión de mercado

Una óptima relación calidad- precio. Una herramienta de alta calidad. Detrás de la marca Stehle se esconde una red de ventas y de producción profesional en todo el mundo.

Stehle - el socio óptimo para el comercio industrial

Tenemos muchos artículos en existencias para su entrega inmediata. Además, muchas herramientas que no están en el catálogo se pueden suministrar. Además, las herramientas también se pueden producir a como herramientas especiales.

Stehle - trabaja continuamente para mejorar

La calidad y la seguridad son de suma importancia. El grupo Stehle las garantiza a través de la certificación ISO.

Stehle - un buen y variado programa

Con sierras circulares, fresas, fresa finger joint, cabezales con cuchillas reversibles, fresas y brocas para, máquinas CNC, herramientas de diamante y herramientas portátiles. Les ofrecemos un amplio programa de productos. Nuestros conocimientos sobre herramientas y producción se mantienen al día gracias a la formación.

Estamos a su disposición para cualquier duda que le pueda surgir.

Su equipo Stehle

ÍNDICE

Sistema de cabezales universales Euro		Página
Cuerpo base de acerol (MAN)		4
Cuerpo base de acero (MAN) inclusief messen geleverd als sets		5
Cuchillas perfiladass Ancho: 40 mm		
Cuchillas para juntas	16/20/24 x 4 mm	6
Cuchillas perfiladas / Deflectores 001 t/m 099 6 - 12		40 x 4 mm
Cuchillas perfiladas / Deflectores 100 t/m 177 13 - 15		40 x 4 mm
Cuchillas perfiladass Ancho: 50 mm		
Cuchillas perfiladas / Deflectores 500 t/m 580 16 - 20		50 x 4 mm
Cuchillas perfiladass Ancho: 50 mm		
Cuchillas perfiladas / Deflectores 200 t/m 233 21 - 23		50 x 5,5 mm
Cuchillas sin perfilar		
Cuchillas sin perfilar 40 mm		23
Cuchillas sin perfilar 50 mm		23
Cuchillas sin perfilar 60 mm		23
Embalaje		
Cuchillas perfiladas:		VP = 2
Cuchillas sin perfilar: VP = 6		
Precio por unidad		

SP sistema de cabezales universales Euro
Standard

Producto

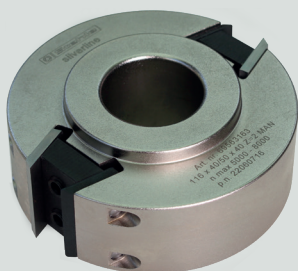

Ejecución



Máquina / Aplicación

- fresadoras de mesa (avance manual)
- para perfilar madera blanda y dura (madera maciza no encolada)

Ejecución

- cuerpo base de acero
- cuchilla de acero SP
- ncl. cuchillas para hacer galces, Deflectores
- ncl. cuñas, tornillos yllave

Ventajas

- Stehle dispone de varios juegos de herramientas en el programa Página 5

Indicaciones

- **Instrucciones de procesamiento:** Instale siempre las cuchillas de moldeo con el deflector correspondiente.
- En el cabezal de corte 69563162 sólo pueden instalarse cuchillas y Deflectores de 40 x 4 mm. En los demás cabezales de corte, las cuchillas y Deflectores 40 x 4 mm y 50 x 4 mm).
- Espesor de la hoja y del deflector 4 mm otros espesores no permitidos

características del producto

Informaciones referente a su pedido

Ø D [mm]	B [mm]	Ø d [mm]	Z	VP [pz.]	número de artículo
096	40	30	2 + 2	1	69563162
116	40/50	30	2 + 2	1	69563160
116	40/50	40	2 + 2	1	69563163
116	40/50	50	2 + 2	1	69563161

Madera

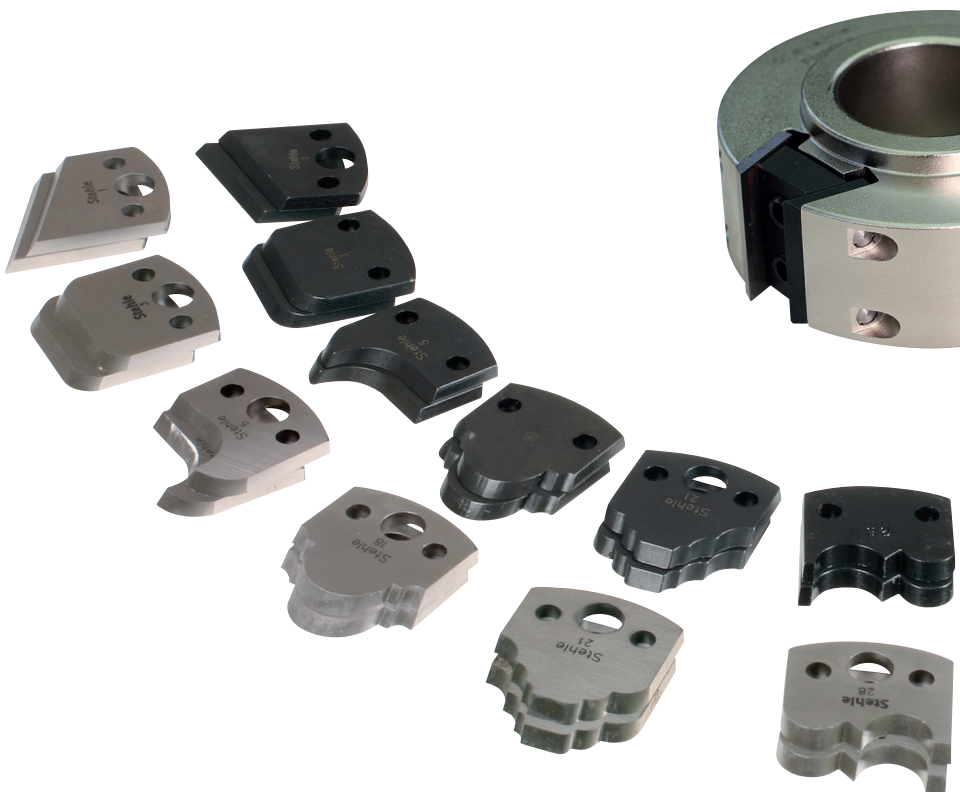

SP sistema de cabezales universales Euro
SETS

Producto

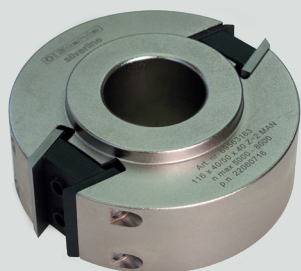

Ejecución



BG-TEST
016-058

silverline

MAN

Máquina / Aplicación

- fresadoras de mesa (avance manual)
- para perfilar madera blanda y dura (madera maciza no encolada)

Ejecución

- Cuerpo base de acero
- Cuchillas de acero SP
- incl. cuchillas para hacer galces, Deflectores
- incl. cuñas, tornillos y llave

Ventajas

- Stehle tiene varios sets de herramientas en su surtido con los perfiles 1-6, 1-12, 1-24, 1-36 enviado en cajas de madera que son disponibles para envia

Indicaciones

- **Instrucciones de procesamiento:** Instale siempre las cuchillas de moldeo con el deflector correspondiente.
- En el cabezal de corte 69563162 sólo pueden instalarse cuchillas y Deflectores de 40 x 4 mm. En los demás cabezales de corte, las cuchillas y Deflectores 40 x 4 mm y 50 x 4 mm).
- **Espesor de la hoja y del deflector 4 mm otros espesores no permitidos**

características del producto
SETS

Informaciones referente a su pedido

Ø D	B	Ø d	Z	VP	número de artículo 6-teilig	número de artículo 12-teilig	número de artículo 24-teilig	número de artículo 36-teilig
[mm]	[mm]	[mm]		[pz.]				
096	40	30	2 + 2	1	56316206	56316212	56316224	56316236
116	40/50	30	2 + 2	1	56316006	56316012	56316024	56316036
116	40/50	40	2 + 2	1	56316306	56316312	56316324	56316336
116	40/50	50	2 + 2	1	56316106	56316112	56316124	56316136



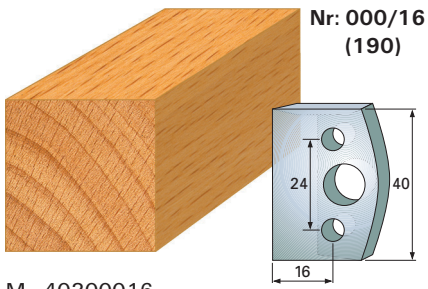

Nr: 000/16
(190)

M 40300016
A 40320016

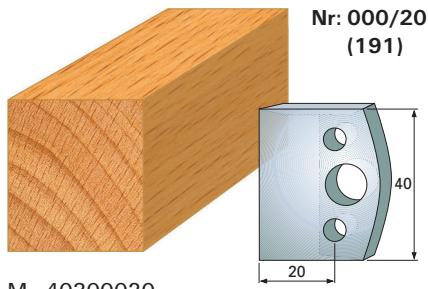

Nr: 000/20
(191)

M 40300020
A 40320020

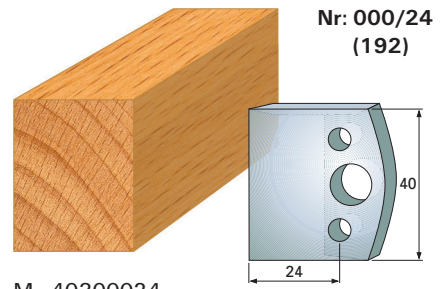

Nr: 000/24
(192)

M 40300024
A 40320024

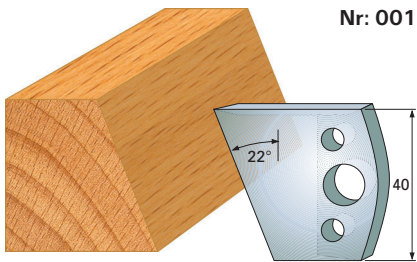

Nr: 001

M 50403001
A 50403201

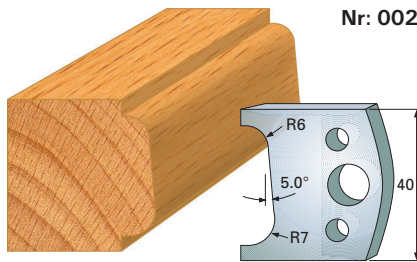

Nr: 002

M 50403002
A 50403202

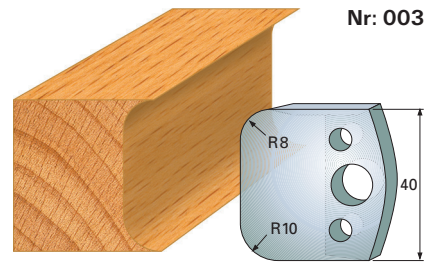

Nr: 003

M 50403003
A 50403203

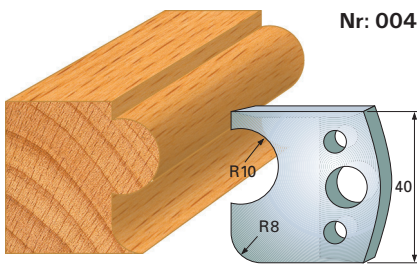

Nr: 004

M 50403004
A 50403204

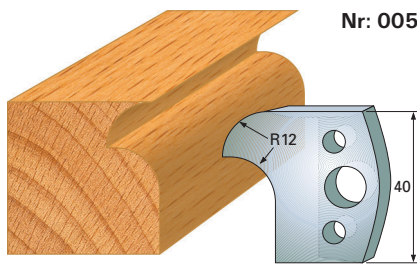

Nr: 005

M 50403005
A 50403205

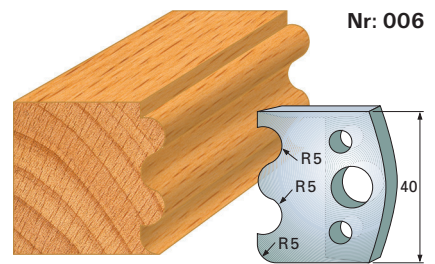

Nr: 006

M 50403006
A 50403206

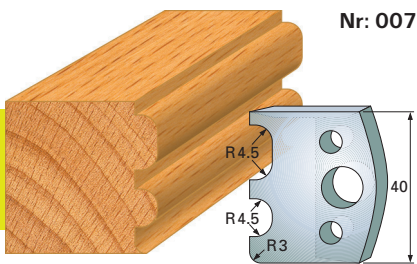

Nr: 007

M 50403007
A 50403207

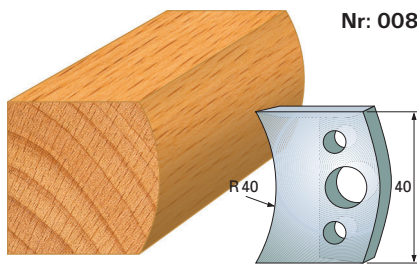

Nr: 008

M 50403008
A 50403208

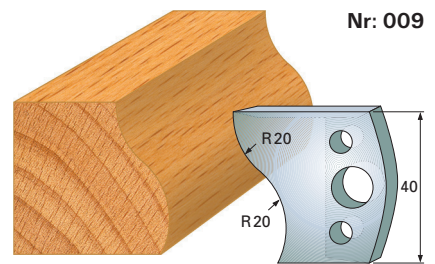

Nr: 009

M 50403009
A 50403209

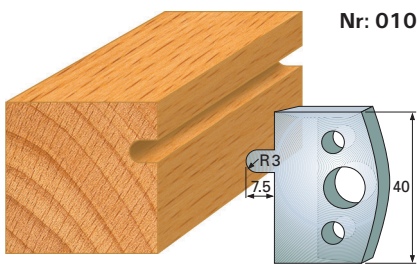

Nr: 010

M 50403010
A 50403210

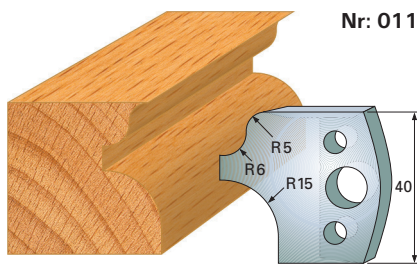

Nr: 011

M 50403011
A 50403211

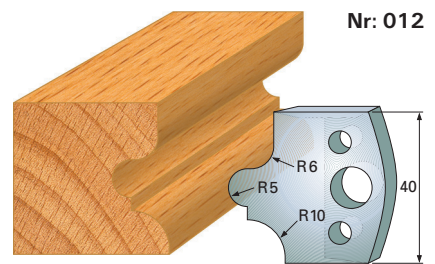

Nr: 012

M 50403012
A 50403212

Madera

M = Cuchillas perfiladas A = Deflectores *Modelo decontimado, hasta fin de existencias

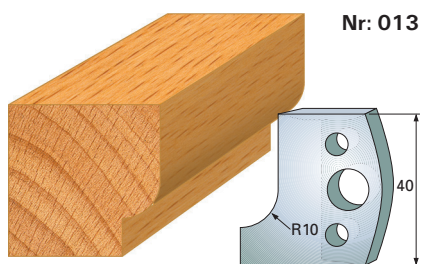

Nr: 013

M 50403013
A 50403213

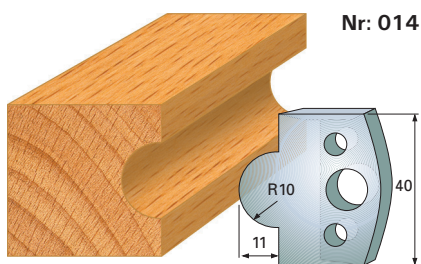

Nr: 014

M 50403014
A 50403214

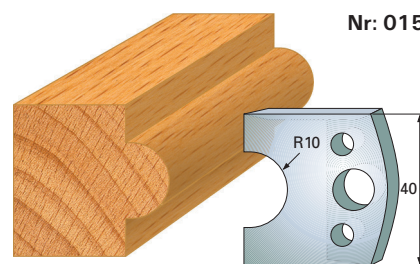

Nr: 015

M 50403015
A 50403215

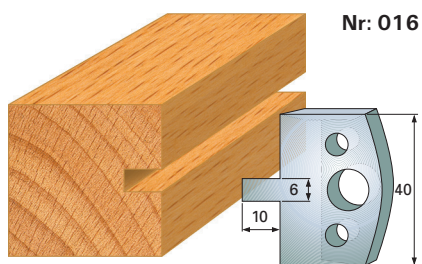

Nr: 016

M 50403016
A 50403216

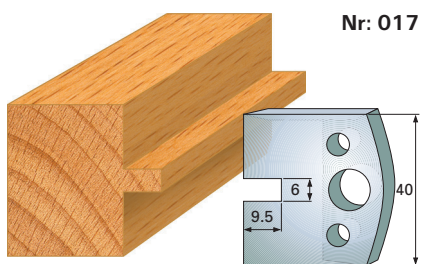

Nr: 017

M 50403017
A 50403217

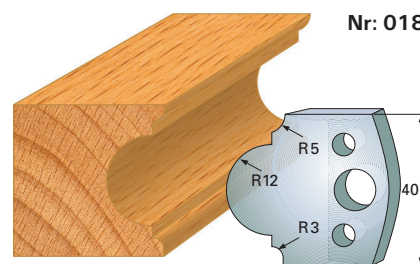

Nr: 018

M 50403018
A 50403218

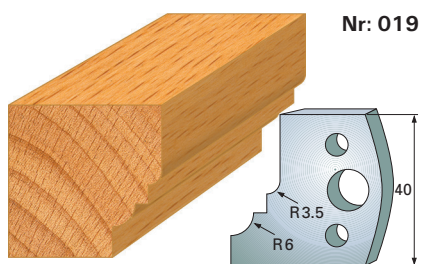

Nr: 019

M 50403019
A 50403219

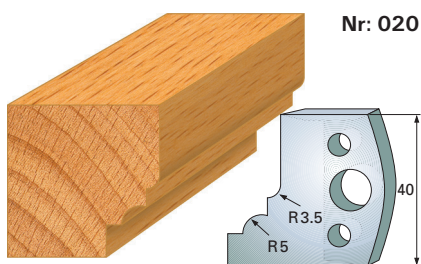

Nr: 020

M 50403020
A 50403220

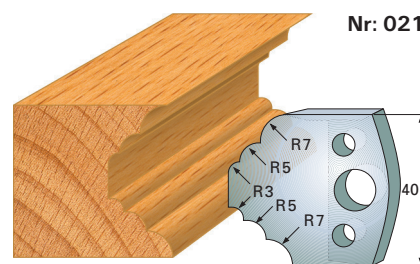

Nr: 021

M 50403021
A 50403221

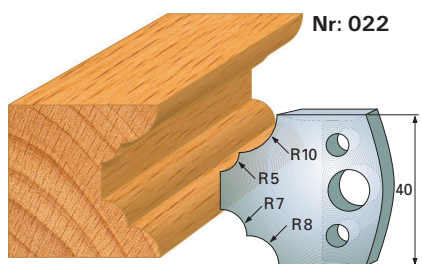

Nr: 022

M 50403022
A 50403222

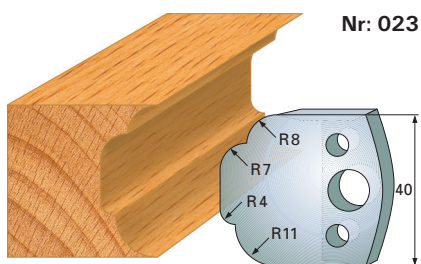

Nr: 023

M 50403023
A 50403223

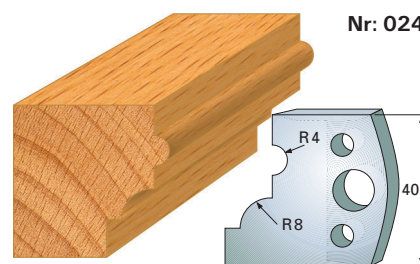

Nr: 024

M 50403024
A 50403224

Madera

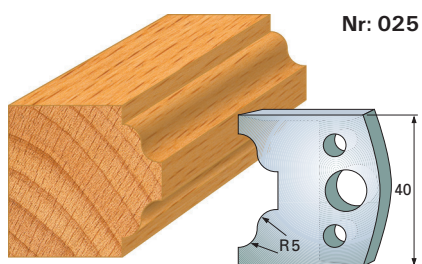

Nr: 025

M 50403025
A 50403225

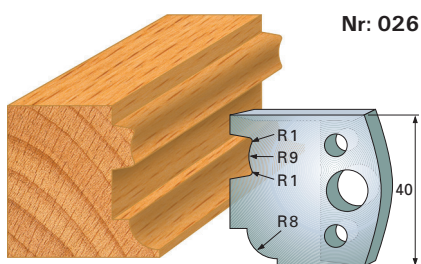

Nr: 026

M 50403026
A 50403226

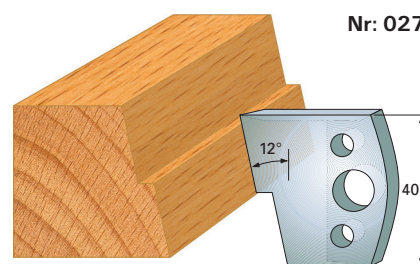

Nr: 027

M 50403027
A 50403227

M = Cuchillas perfiladas A = Deflectores *Modelo decontinado, hasta fin de existencias

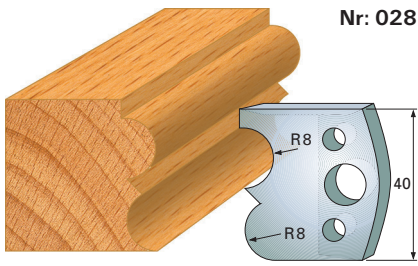

Nr: 028

M 50403028
A 50403228

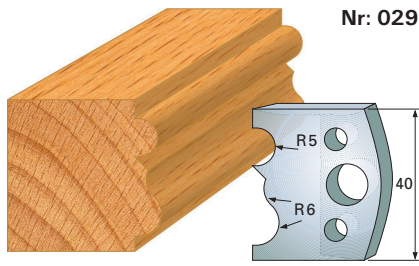

Nr: 029

M 50403029
A 50403229

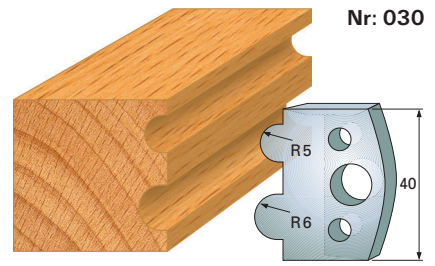

Nr: 030

M 50403030
A 50403230

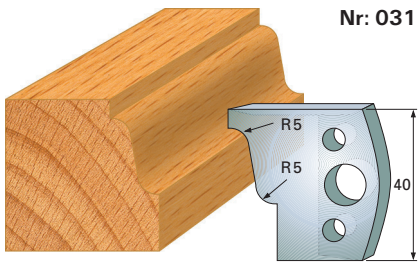

Nr: 031

M 50403031
A 50403231

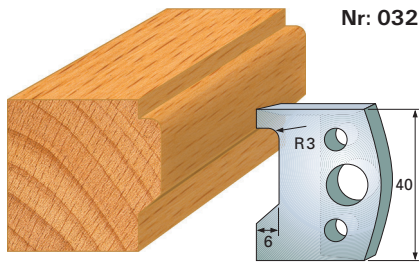

Nr: 032

M 50403032
A 50403232

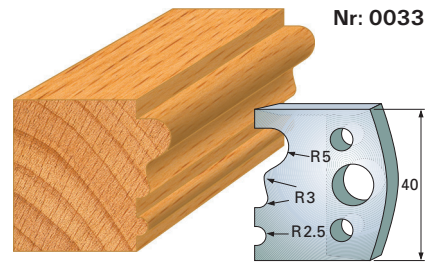

Nr: 0033

M 50403033
A 50403233

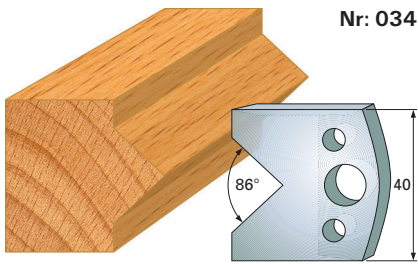

Nr: 034

M 50403034
A 50403234

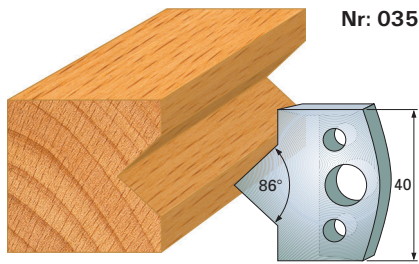

Nr: 035

M 50403035
A 50403235

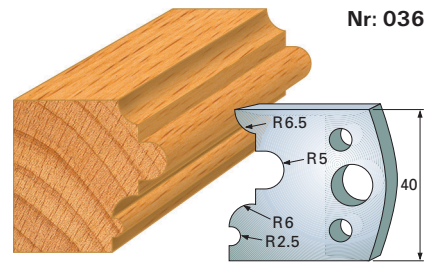

Nr: 036

M 50403036
A 50403236

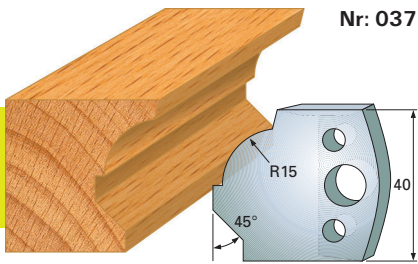

Nr: 037

M 50403037
A 50403237

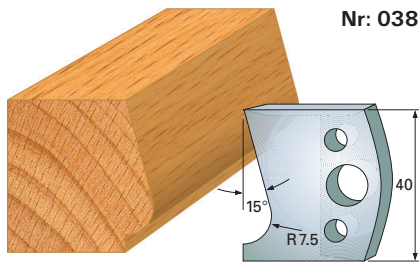

Nr: 038

M 50403038
A 50403238

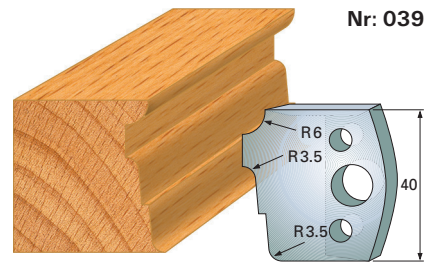

Nr: 039

M 50403039
A 50403239

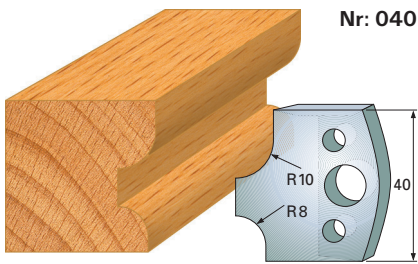

Nr: 040

M 50403040
A 50403240

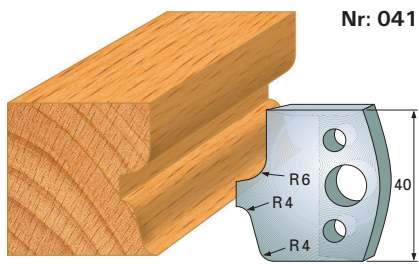

Nr: 041

M 50403041
A 50403241

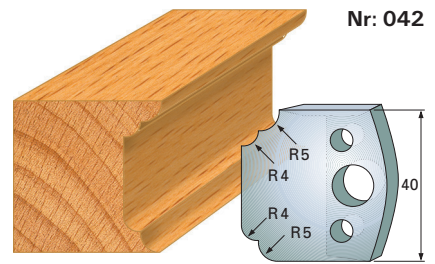

Nr: 042

M 50403042
A 50403242

Madera

M = Cuchillas perfiladas A = Deflectores *Modelo decontimado, hasta fin de existencias

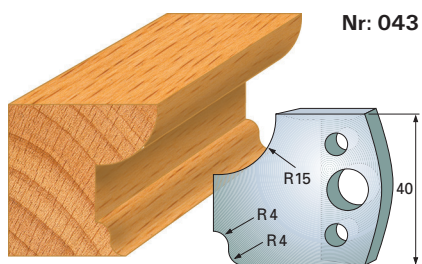

Nr: 043

M 50403043
A 50403243

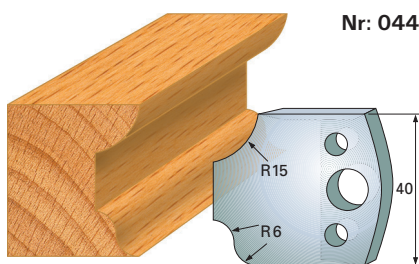

Nr: 044

M 50403044
A 50403244

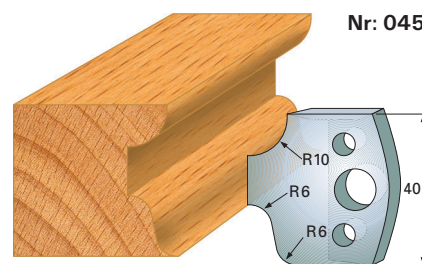

Nr: 045

M 50403045
A 50403245

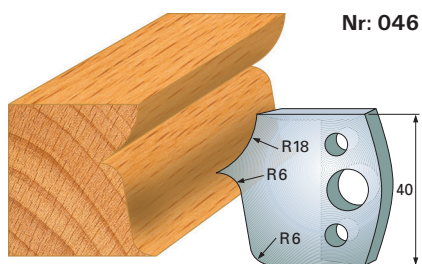

Nr: 046

M 50403046
A 50403246

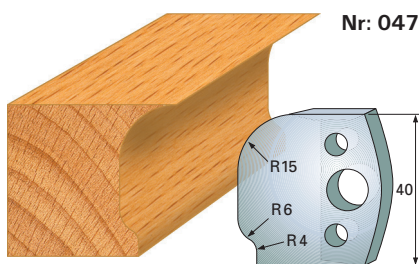

Nr: 047

M 50403047
A 50403247

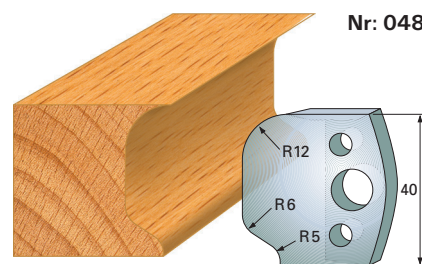

Nr: 048

M 50403048
A 50403248

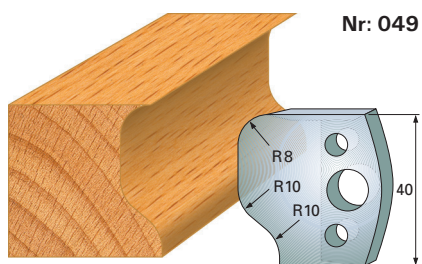

Nr: 049

M 50403049
A 50403249

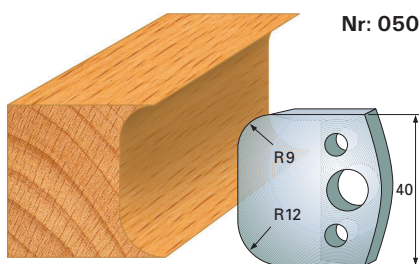

Nr: 050

M 50403050
A 50403250

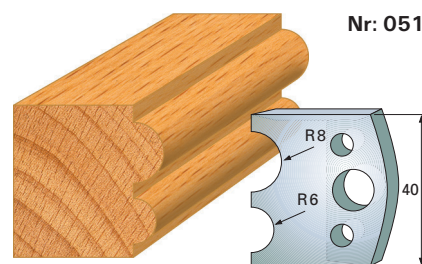

Nr: 051

M 50403051
A 50403251

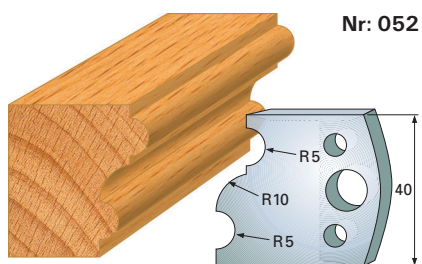

Nr: 052

M 50403052
A 50403252

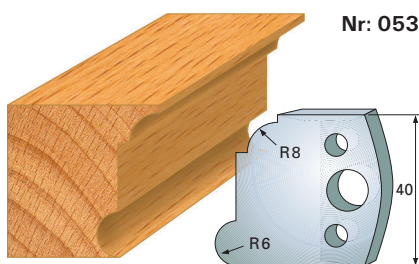

Nr: 053

M 50403053
A 50403253

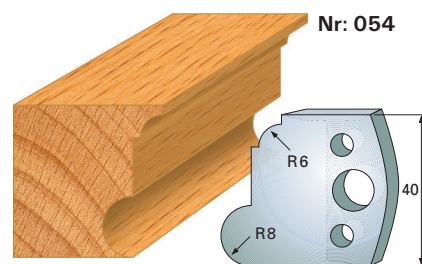

Nr: 054

M 50403054
A 50403254

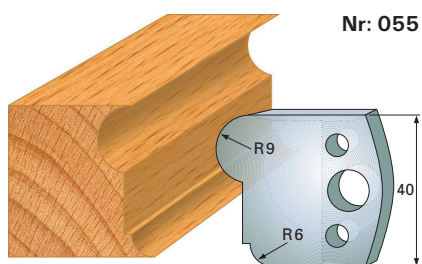

Nr: 055

M 50403055
A 50403255

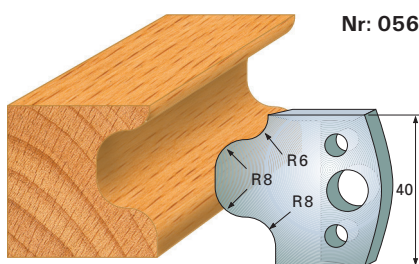

Nr: 056

M 50403056
A 50403256

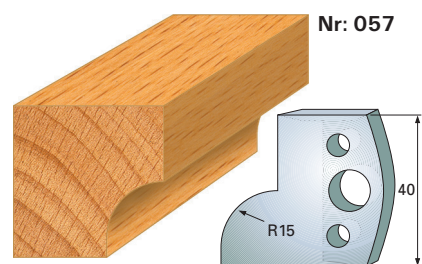

Nr: 057

M 50403057
A 50403257

Madera

M = Cuchillas perfiladas A = Deflectores *Modelo decontinado, hasta fin de existencias

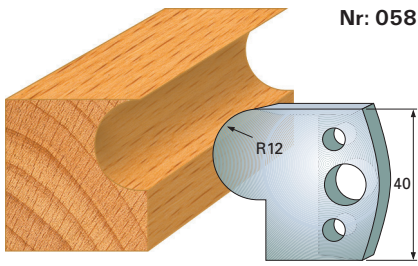

Nr: 058

M 50403058
A 50403258

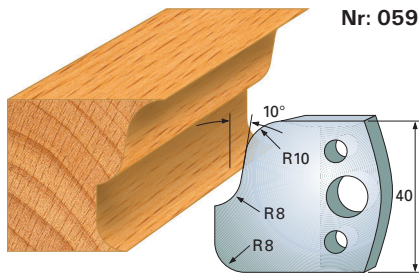

Nr: 059

M 50403059
A 50403259

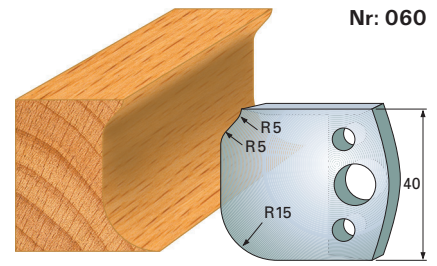

Nr: 060

M 50403060
A 50403260

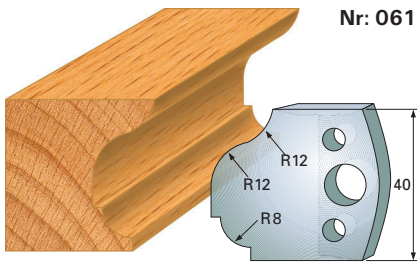

Nr: 061

M 50403061
A 50403261

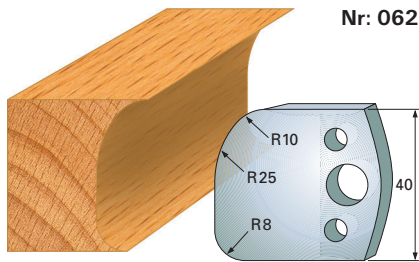

Nr: 062

M 50403062
A 50403262

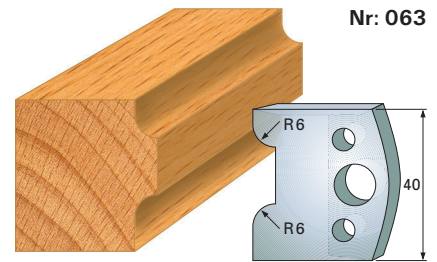

Nr: 063

M 50403063
A 50403263

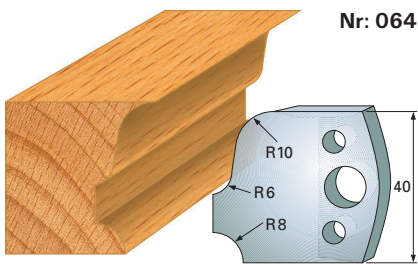

Nr: 064

M 50403064
A 50403264

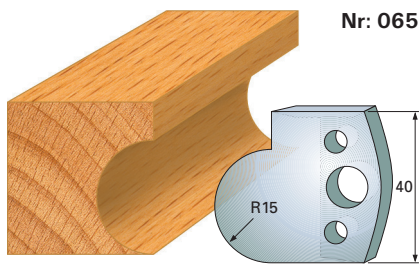

Nr: 065

M 50403065
A 50403265

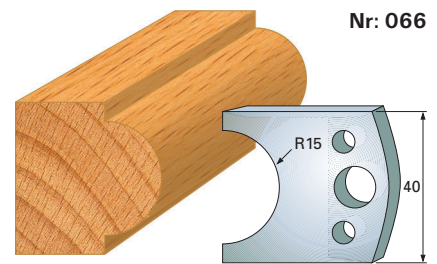

Nr: 066

M 50403066
A 50403266

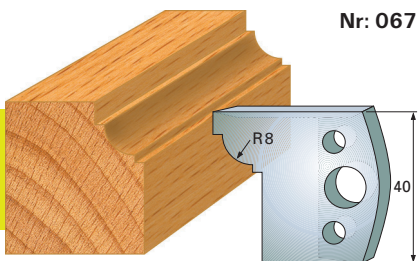

Nr: 067

M 50403067
A 50403267

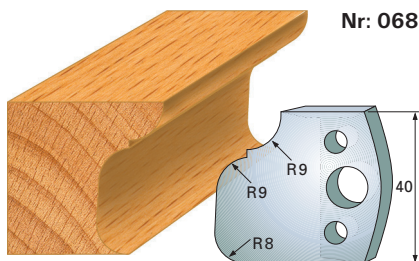

Nr: 068

M 50403068
A 50403268

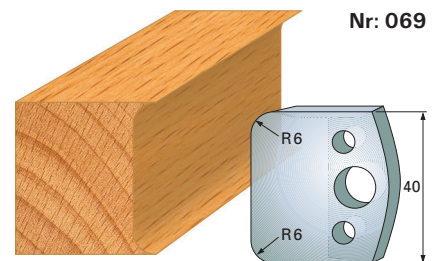

Nr: 069

M 50403069
A 50403269

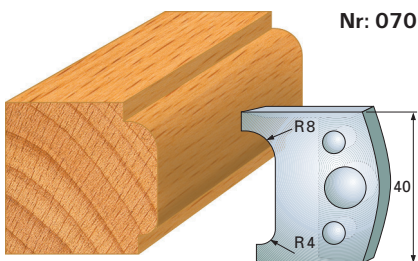

Nr: 070

M 50403070
A 50403270

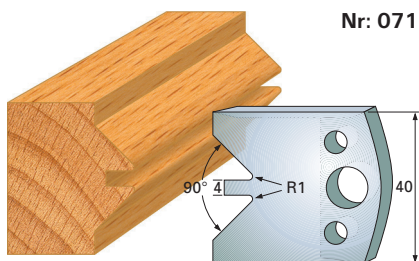

Nr: 071

M 50403071
A 50403271

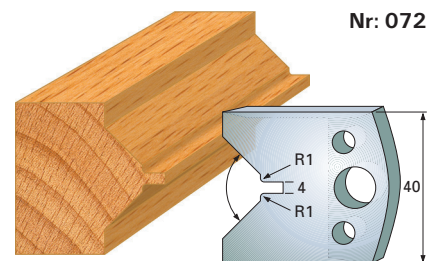

Nr: 072

M 50403072
A 50403272

Madera

M = Cuchillas perfiladas A = Deflectores *Modelo decontimado, hasta fin de existencias

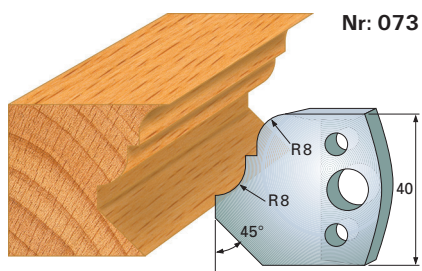

Nr: 073

M 50403073
A 50403273

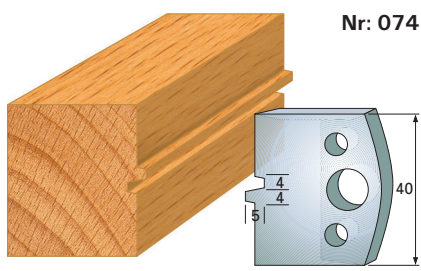

Nr: 074

M 50403074
A 50403274

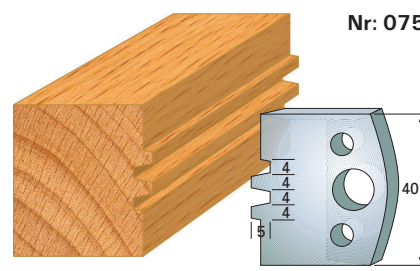

Nr: 075

M 50403075
A 50403275

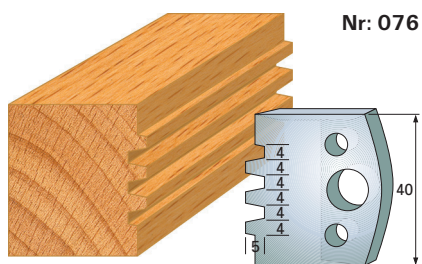

Nr: 076

M 50403076
A 50403276

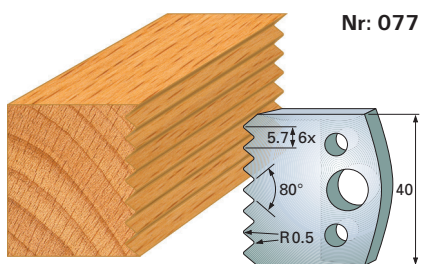

Nr: 077

M 50403077
A 50403277

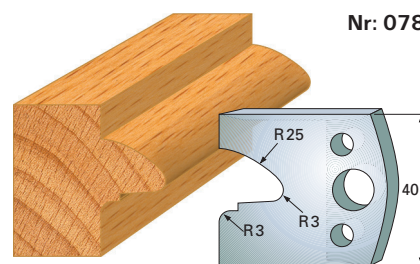

Nr: 078

M 50403078
A 50403278

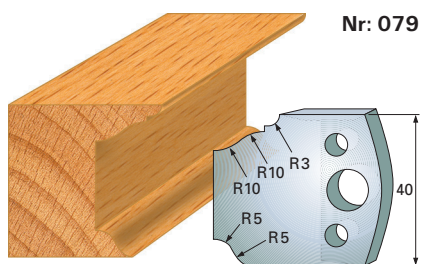

Nr: 079

M 50403079
A 50403279

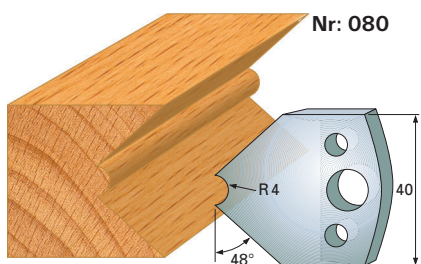

Nr: 080

M 50403080
A 50403280

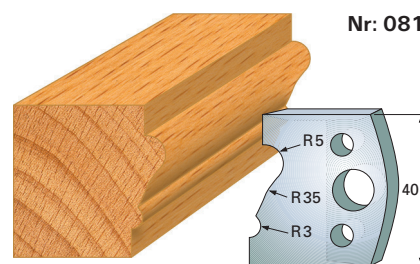

Nr: 081

M 50403081
A 50403281

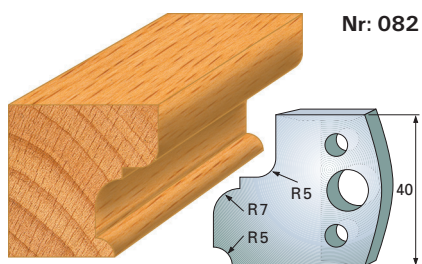

Nr: 082

M 50403082
A 50403282

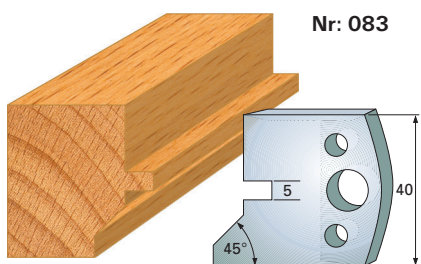

Nr: 083

M 50403083
A 50403283

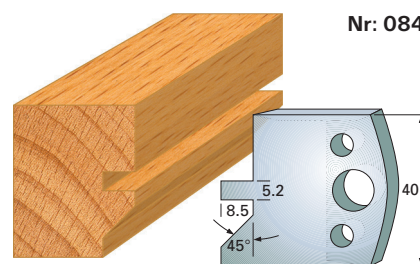

Nr: 084

M 50403084
A 50403284

Madera

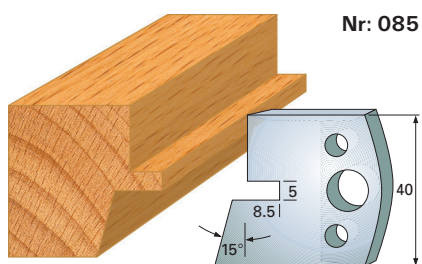

Nr: 085

M 50403085
A 50403285

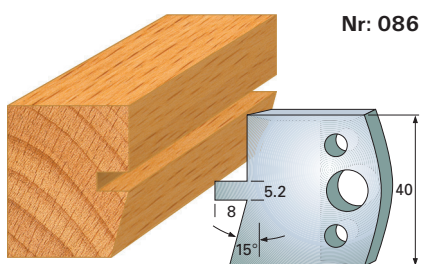

Nr: 086

M 50403086
A 50403286

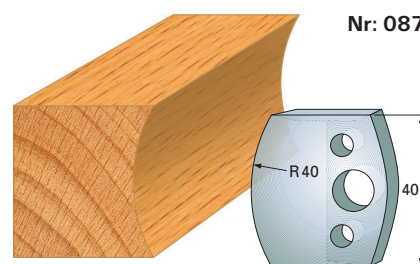

Nr: 087

M 50403087
A 50403287

M = Cuchillas perfiladas A = Deflectores *Modelo decontinado, hasta fin de existencias

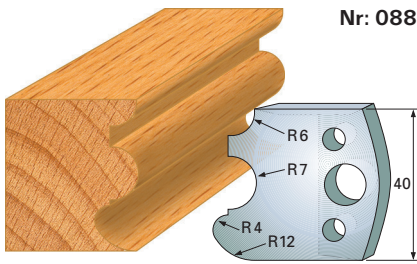

Nr: 088

M 50403088
A 50403288

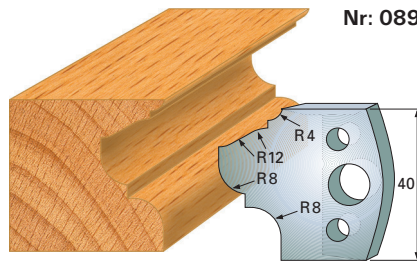

Nr: 089

M 50403089
A 50403289

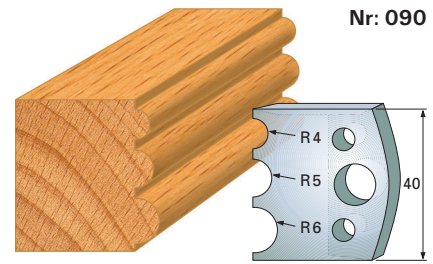

Nr: 090

M 50403090
A 50403290

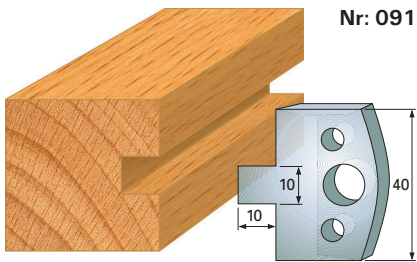

Nr: 091

M 50403091
A 50403291

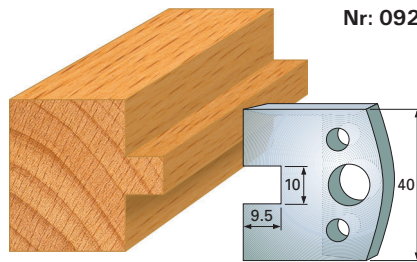

Nr: 092

M 50403092
A 50403292

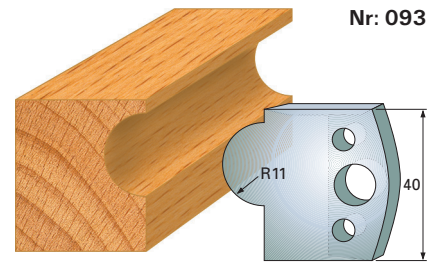

Nr: 093

M 50403093
A 50403293

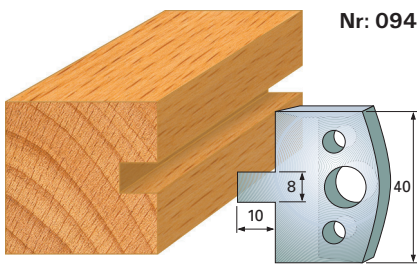

Nr: 094

M 50403094
A 50403294

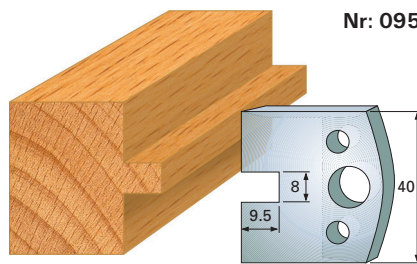

Nr: 095

M 50403095
A 50403295

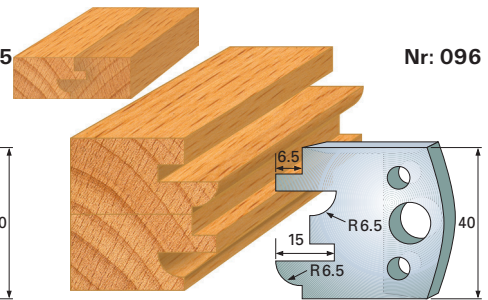

Nr: 096

M 50403096
A 50403296

Konterprofil K-1

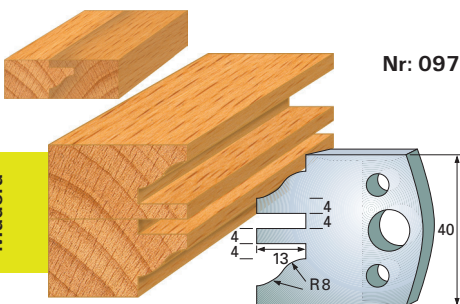

Nr: 097

M 50403097
A 50403297

Conterprofil K-2

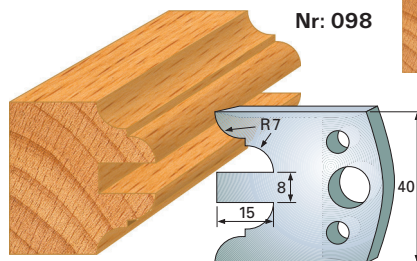

Nr: 098

M 50403098
A 50403298

Konterprofil K-3

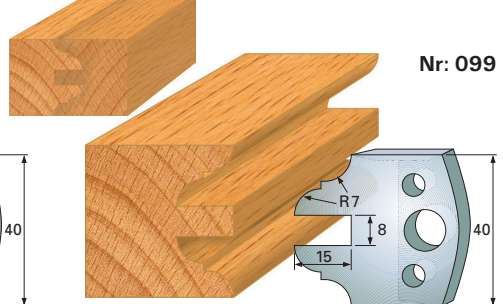

Nr: 099

M 50403099
A 50403299

Konterprofil K-4

Madera

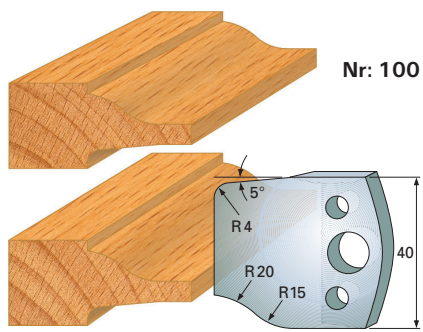

Nr: 100

M 50403100
A 50403300

Abplattmesser

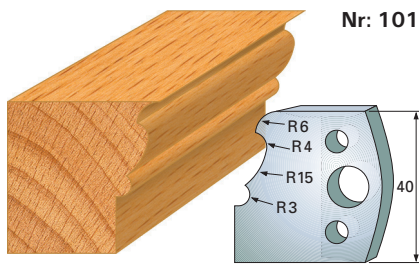

Nr: 101

M 50403101
A 50403301

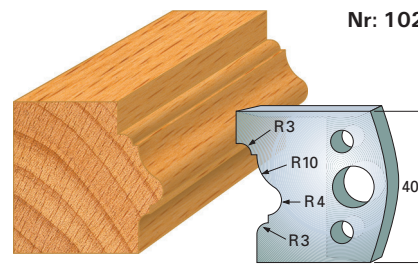

Nr: 102

M 50403102
A 50403302

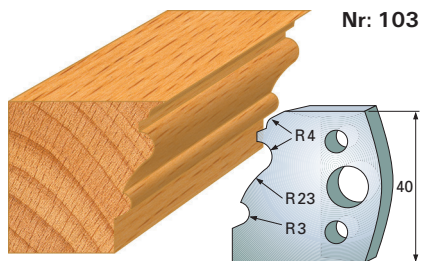

Nr: 103

M 50403103
A 50403303

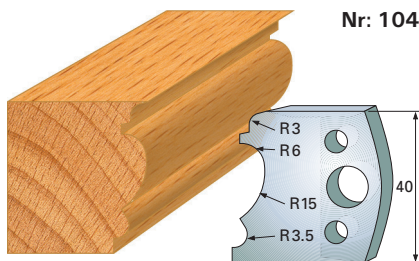

Nr: 104

M 50403104
A 50403304

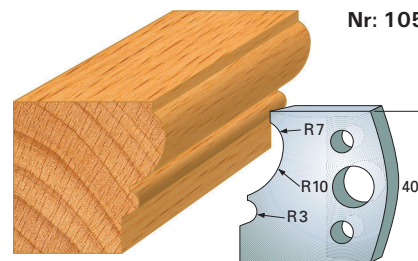

Nr: 105

M 50403105
A 50403305

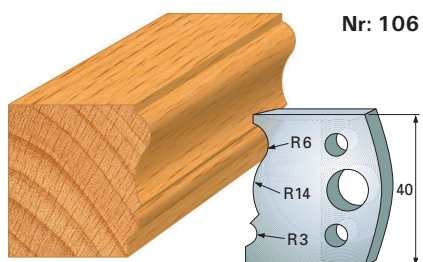

Nr: 106

M 50403106
A 50403306

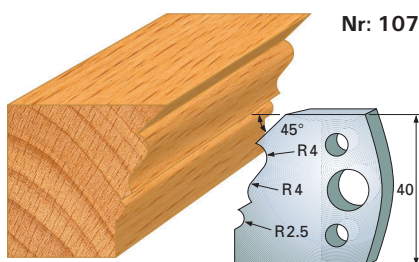

Nr: 107

M 50403107
A 50403307

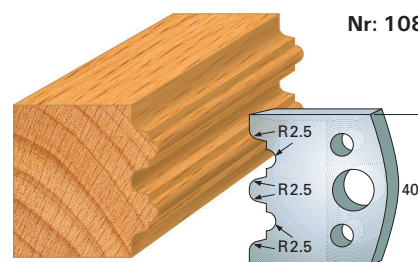

Nr: 108

M 50403108
A 50403308

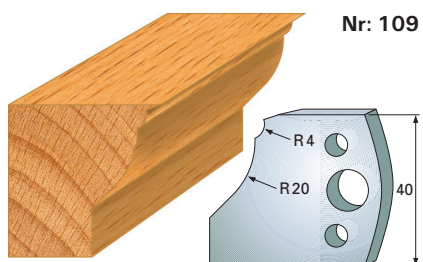

Nr: 109

M 50403109
A 50403309

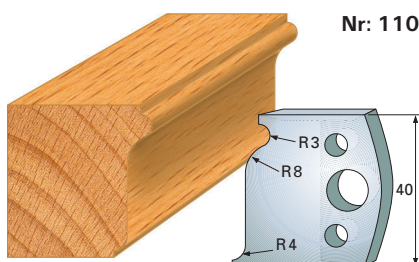

Nr: 110

M 50403110
A 50403310

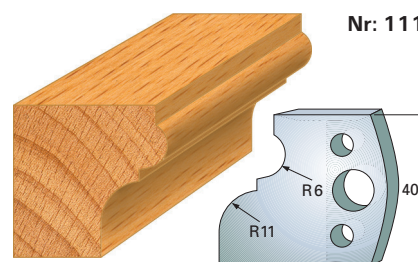

Nr: 111

M 50403111
A 50403311

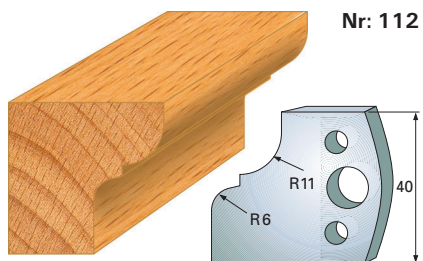

Nr: 112

M 50403112
A 50403312

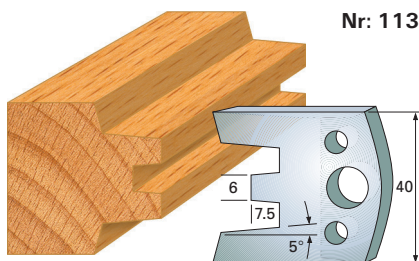

Nr: 113

M 50403113
A 50403313

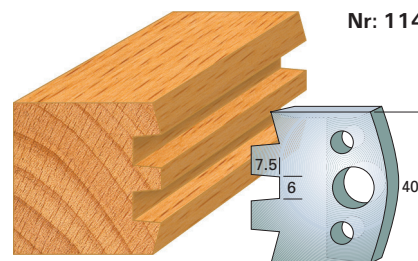

Nr: 114

M 50403114
A 50403314

Madera

M = Cuchillas perfiladas A = Deflectores *Modelo decontinado, hasta fin de existencias

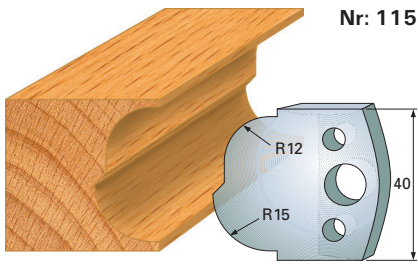

Nr: 115

M 50403115
A 50403315

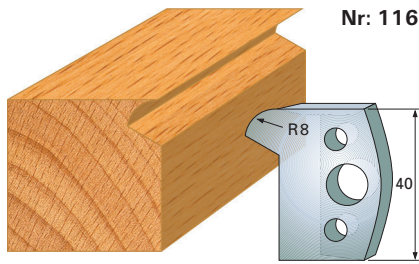

Nr: 116

M 50403116
A 50403316

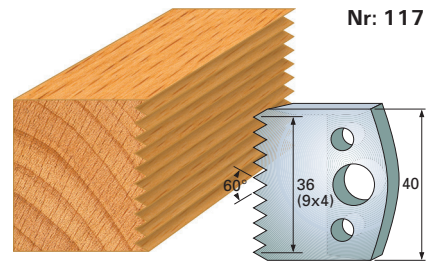

Nr: 117

M 50403117
A 50403317

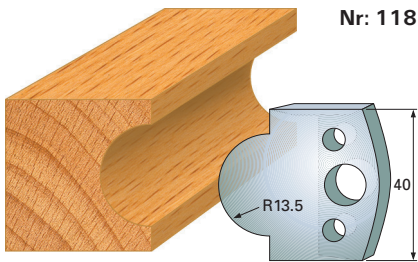

Nr: 118

M 50403118
A 50403318

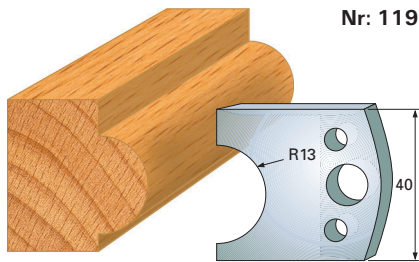

Nr: 119

M 50403119
A 50403319

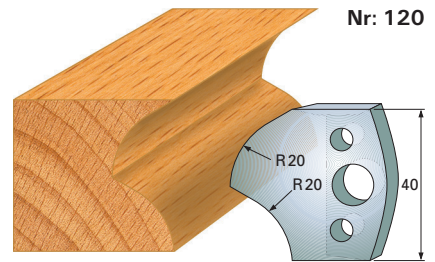

Nr: 120

M 50403120
A 50403320

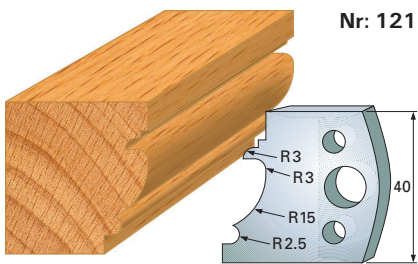

Nr: 121

M 50403121
A 50403321

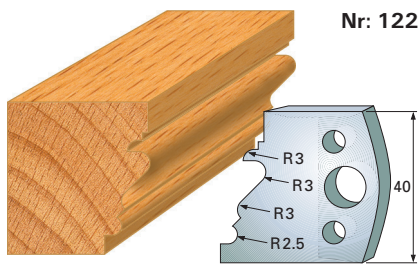

Nr: 122

M 50403122
A 50403322

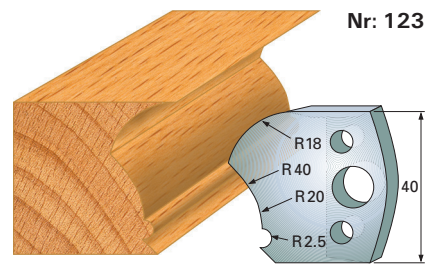

Nr: 123

M 50403123
A 50403323

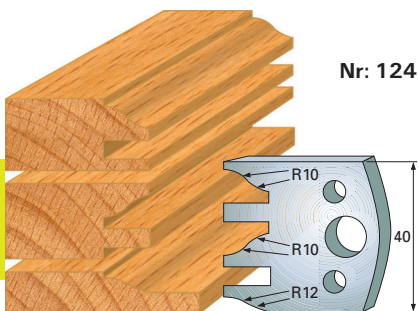

Nr: 124

M 50403124
A 50403324

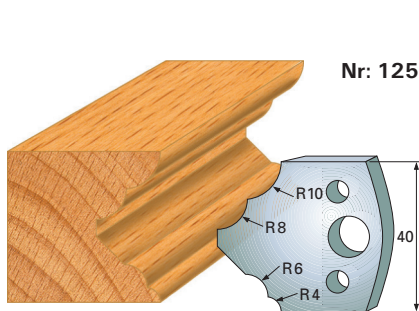

Nr: 125

M 50403125
A 50403325

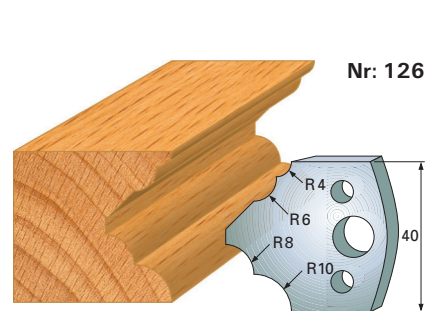

Nr: 126

M 50403126
A 50403326

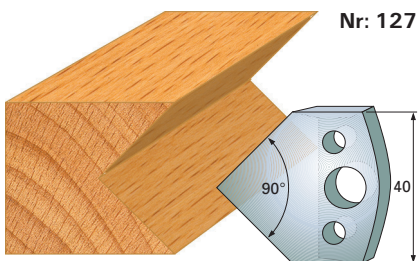

Nr: 127

M 50403127
A 50403327

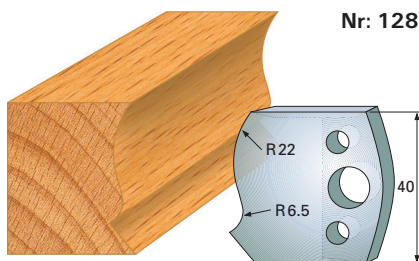

Nr: 128

M 50403128
A 50403328

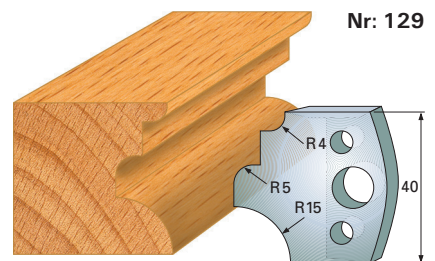

Nr: 129

M 50403129
A 50403329

Madera

M = Cuchillas perfiladas A = Deflectores *Modelo decontimado, hasta fin de existencias

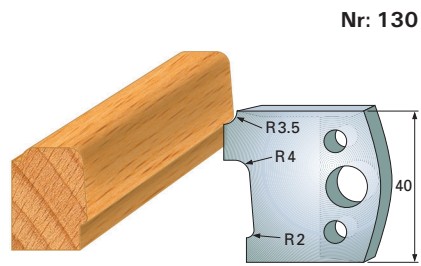

Nr: 130

M 50403130
A 50403330

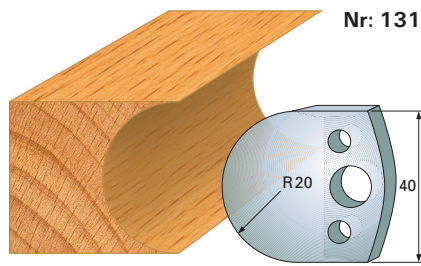

Nr: 131

M 50403131
A 50403331

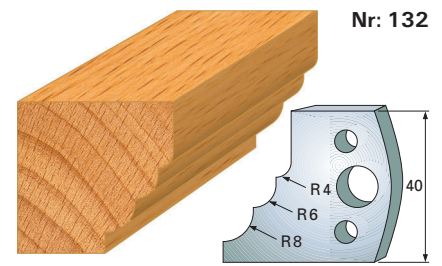

Nr: 132

M 50403132
A 50403332

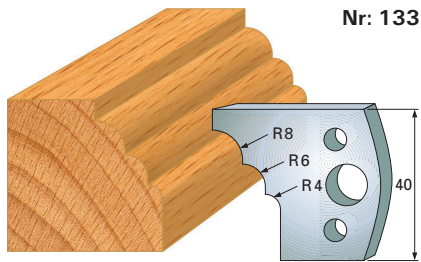

Nr: 133

M 50403133
A 50403333

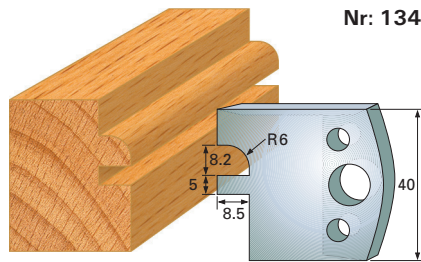

Nr: 134

M 50403134
A 50403334

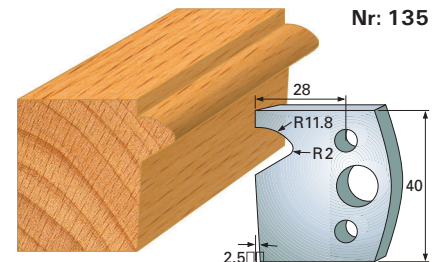

Nr: 135

M 50403135
A 50403335

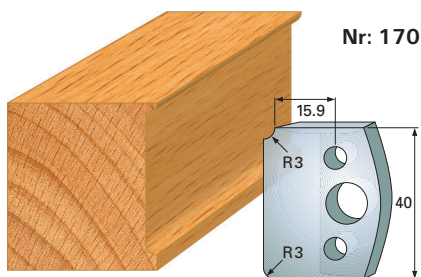

Nr: 170

M 50403170
A 50403370

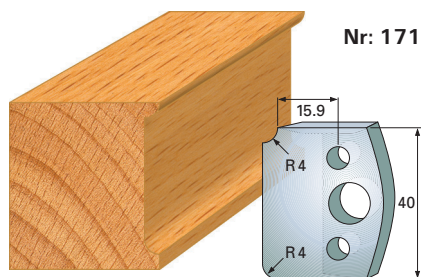

Nr: 171

M 50403171
A 50403371

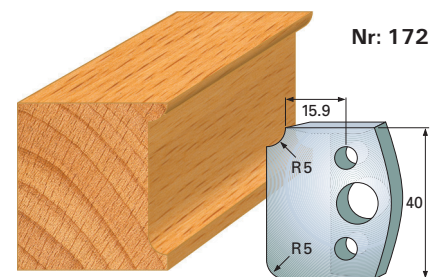

Nr: 172

M 50403172
A 50403372

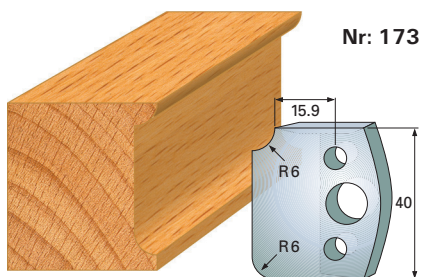

Nr: 173

M 50403173
A 50403373

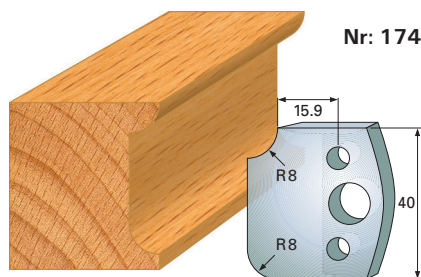

Nr: 174

M 50403174
A 50403374

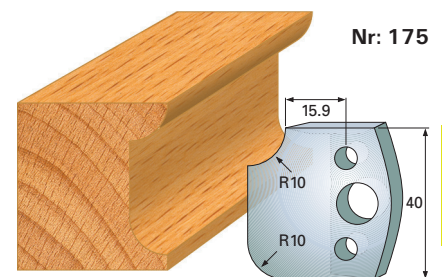

Nr: 175

M 50403175
A 50403375

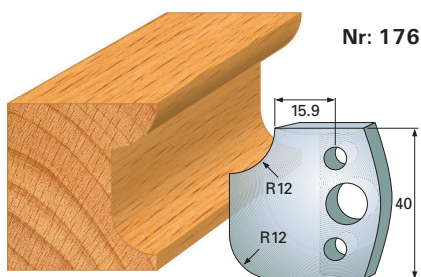

Nr: 176

M 50403176
A 50403376

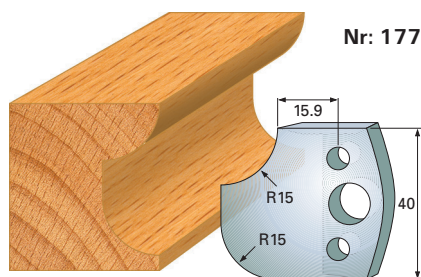

Nr: 177

M 50403177
A 50403377

Madera

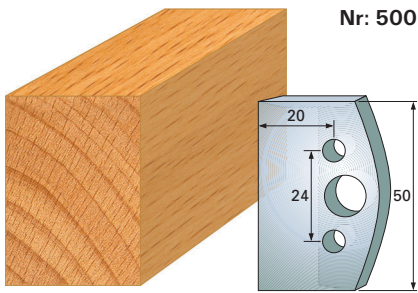

Nr: 500

M 50503000
A 50503200

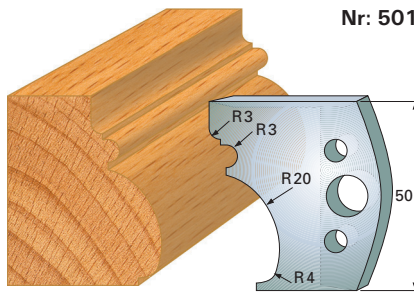

Nr: 501

M 50503001
A 50503201

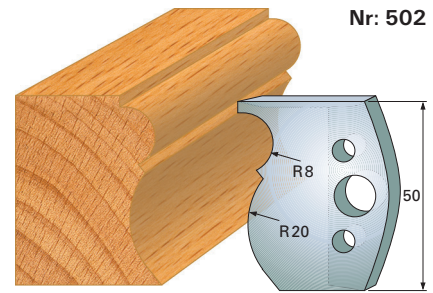

Nr: 502

M 50503002
A 50503202

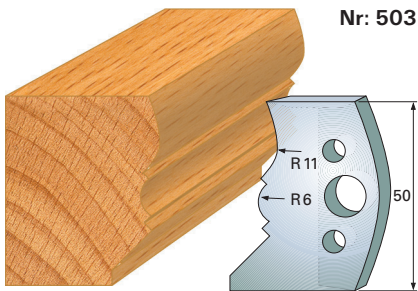

Nr: 503

M 50503003
A 50503203

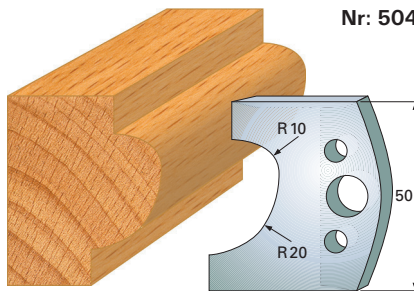

Nr: 504

M 50503004
A 50503204

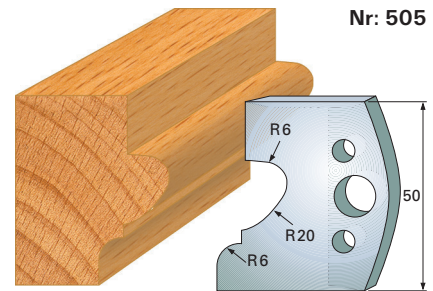

Nr: 505

M 50503005
A 50503205

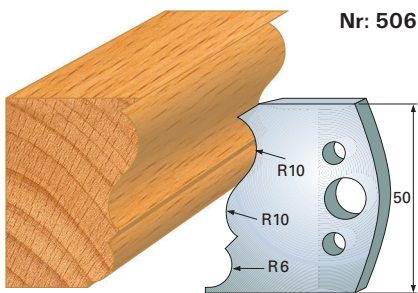

Nr: 506

M 50503006
A 50503206

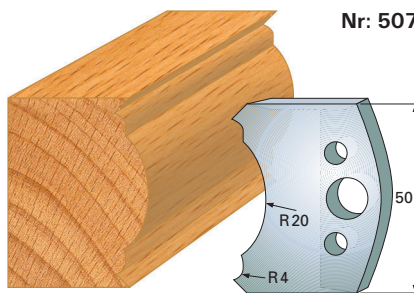

Nr: 507

M 50503007
A 50503207

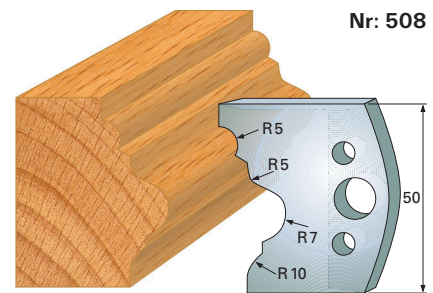

Nr: 508

M 50503008
A 50503208

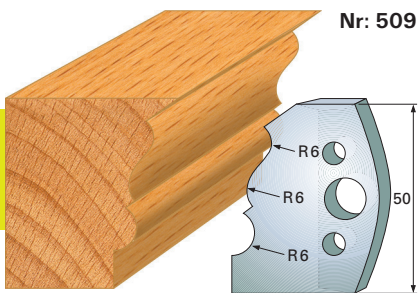

Nr: 509

M 50503009
A 50503209

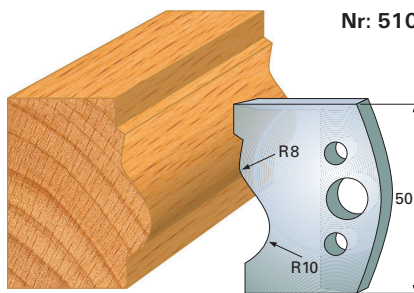

Nr: 510

M 50503010
A 50503210

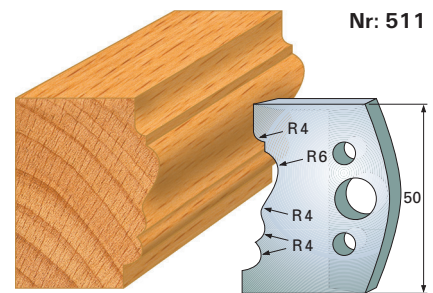

Nr: 511

M 50503011
A 50503211

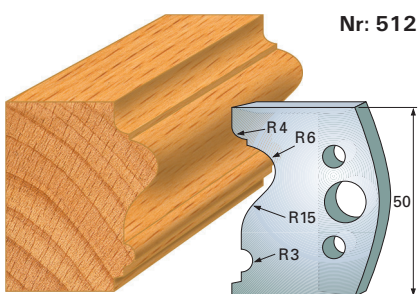

Nr: 512

M 50503012
A 50503212

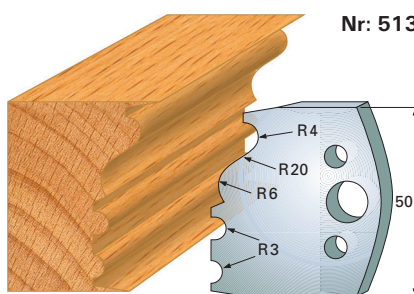

Nr: 513

M 50503013
A 50503213

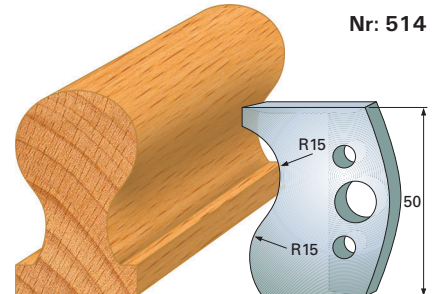

Nr: 514

M 50503014
A 50503214

Madera

M = Cuchillas perfiladas A = Deflectores *Modelo decontimado, hasta fin de existencias

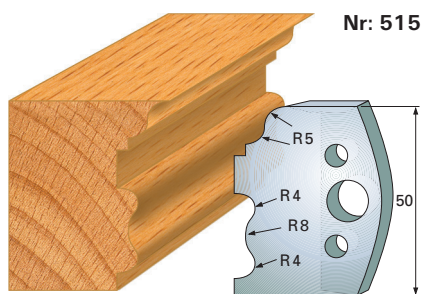

M 50503015
A 50503215

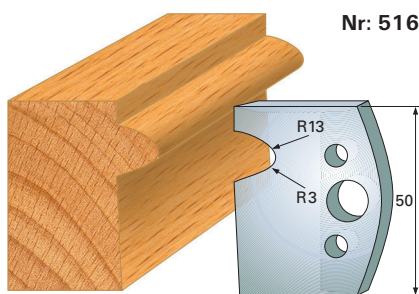

M 50503016
A 50503216

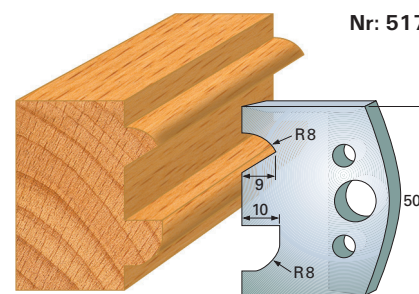

M 50503017
A 50503217

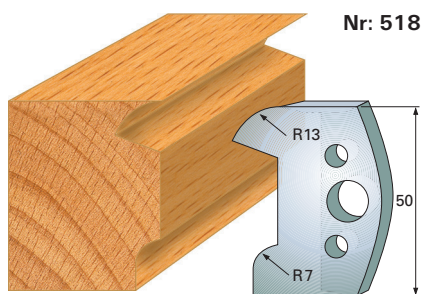

M 50503018
A 50503218

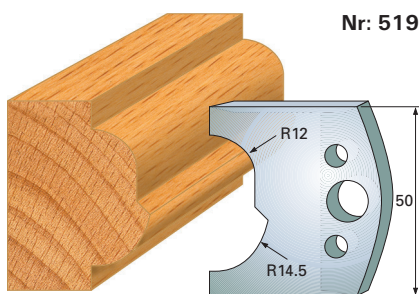

M 50503019
A 50503219

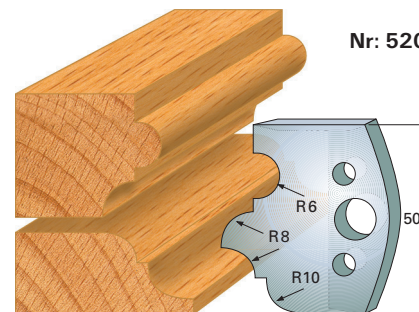

M 50503020
A 50503220

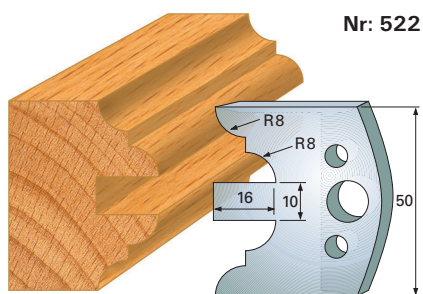

M 50503022
A 50503222

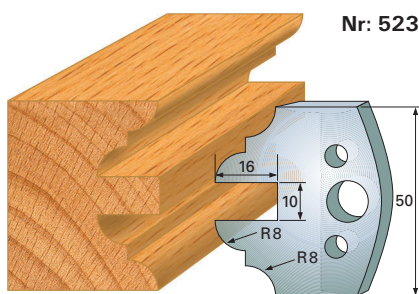

M 50503023
A 50503223

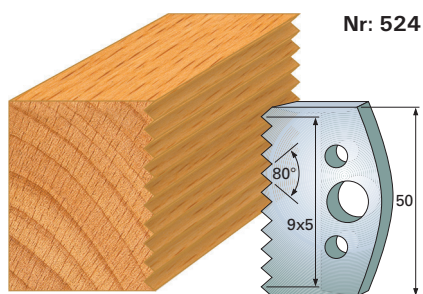
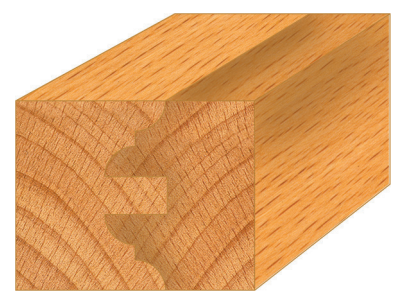

M 50503024
A 50503224

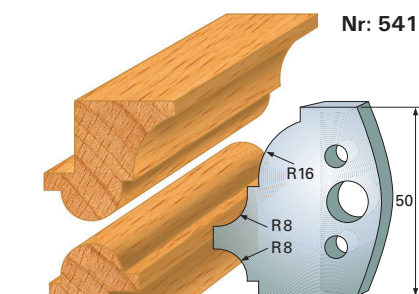

M 50503041
A 50503241

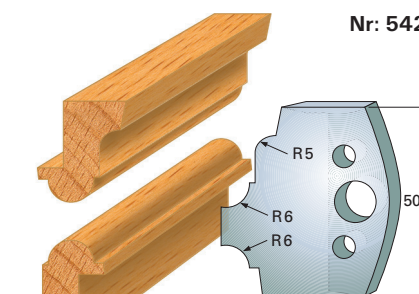

M 50503042
A 50503242

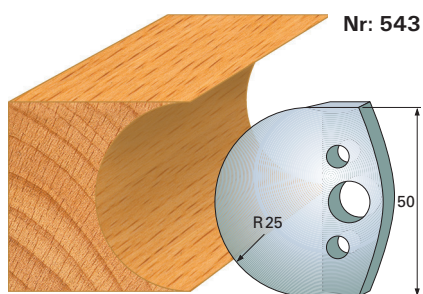

M 50503043
A 50503243

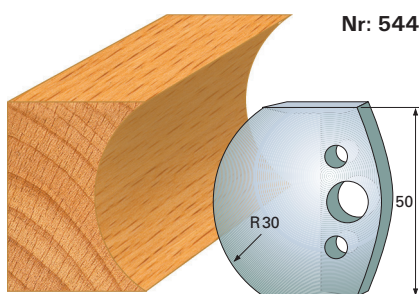

M 50503044
A 50503244

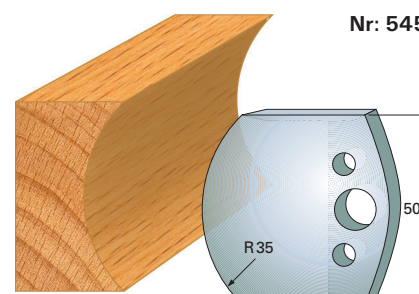

M 50503045
A 50503245

Madera

M = Cuchillas perfiladas A = Deflectores *Modelo decontinado, hasta fin de existencias

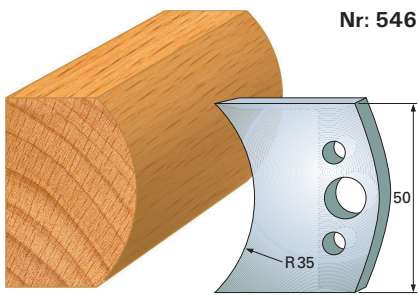

Nr: 546

M 50503046
A 50503246

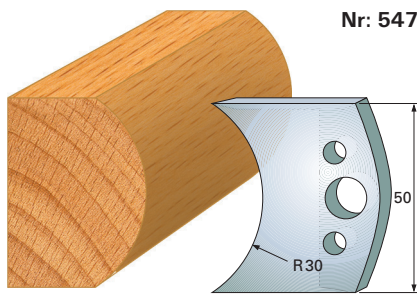

Nr: 547

M 50503047
A 50503247

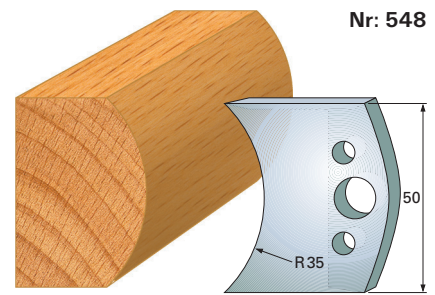

Nr: 548

M 50503048
A 50503248

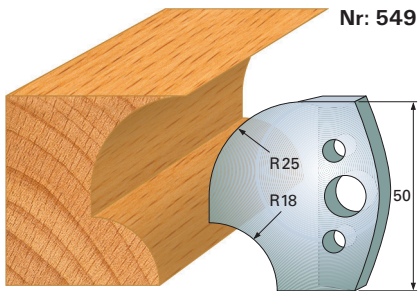

Nr: 549

M 50503049
A 50503249

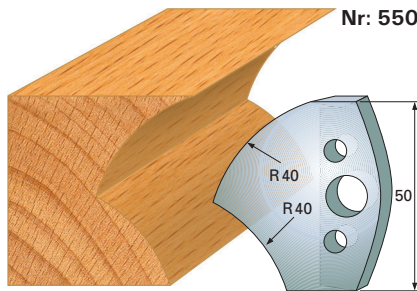

Nr: 550

M 50503050
A 50503250

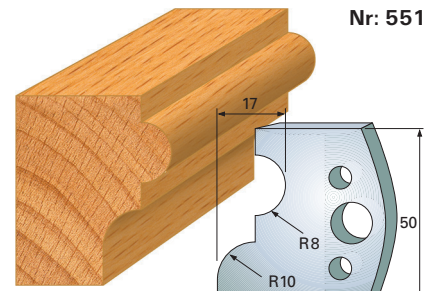

Nr: 551

M 50503051
A 50503251

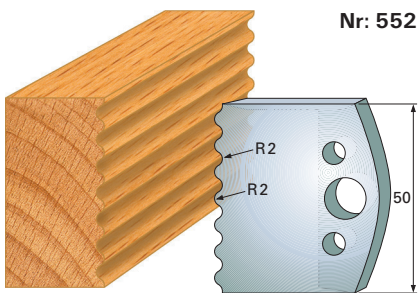

Nr: 552

M 50503052
A 50503252

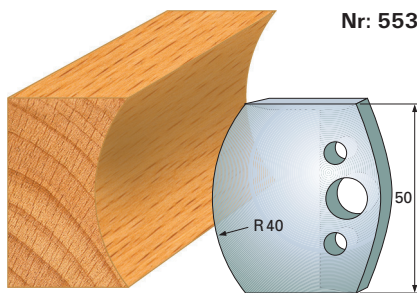

Nr: 553

M 50503053
A 50503253

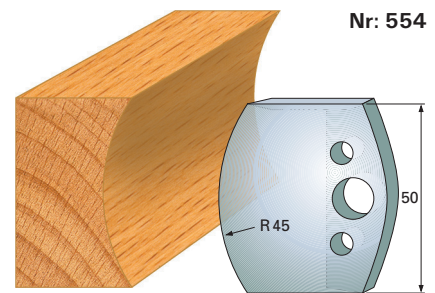

Nr: 554

M 50503054
A 50503254

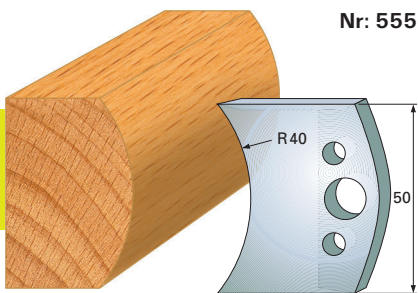

Nr: 555

M 50503055
A 50503255

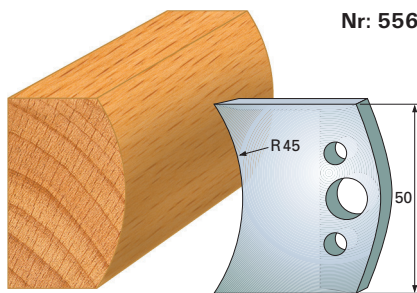

Nr: 556

M 50503056
A 50503256

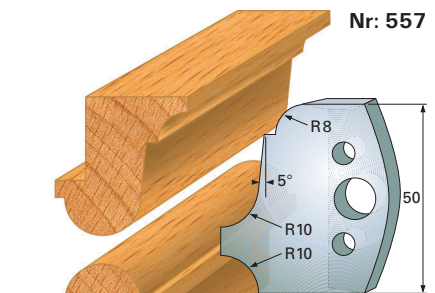

Nr: 557

M 50503057
A 50503257

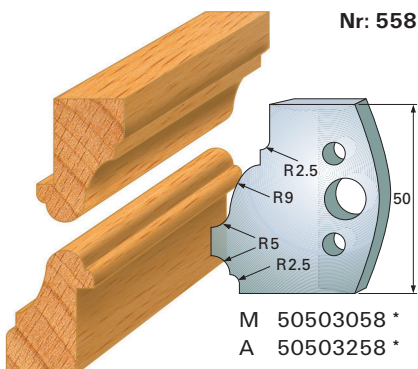

Nr: 558

M 50503058 *
A 50503258 *

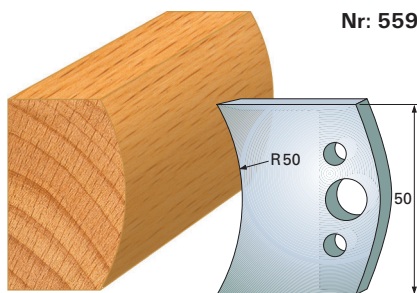

Nr: 559

M 50503059 *
A 50503259 *

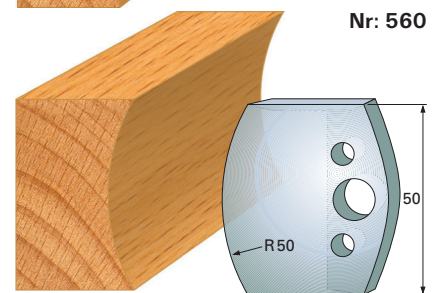

Nr: 560

M 50503060 *
A 50503260 *

M = Cuchillas perfiladas A = Deflectores *Modelo decontimado, hasta fin de existencias

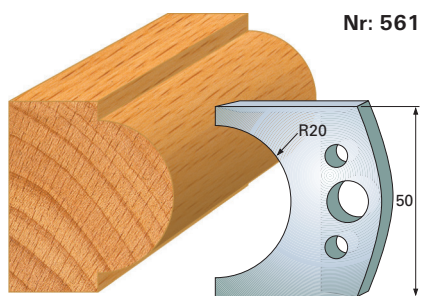

Nr: 561

M 50503061 * vervallen
A 50503261 * vervallen

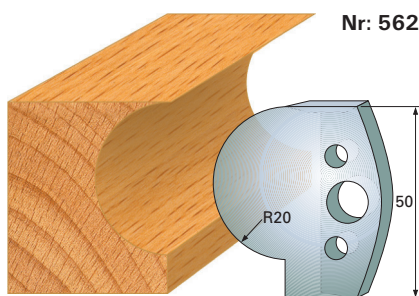

Nr: 562

M 50503062 *
A 50503262 *

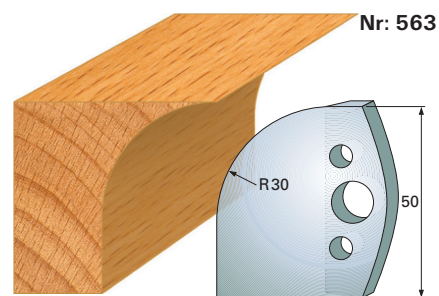

Nr: 563

M 50503063 *
A 50503263 *

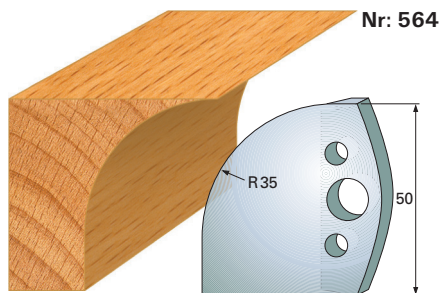

Nr: 564

M 50503064 *
A 50503264 *

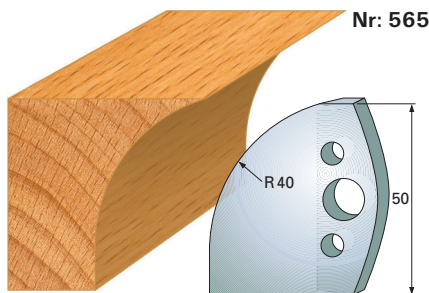

Nr: 565

M 50503065 *
A 50503265 *

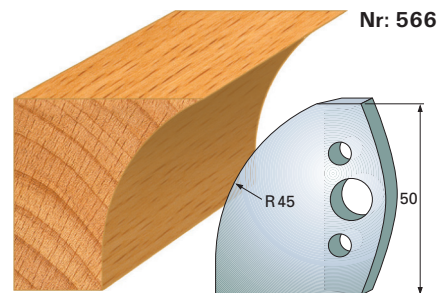

Nr: 566

M 50503066 *
A 50503266 *

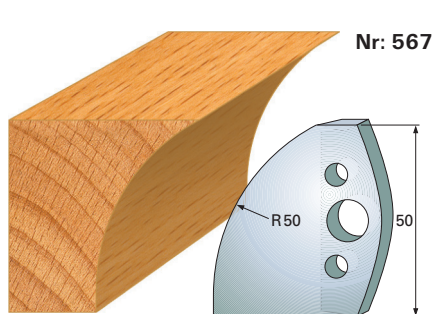

Nr: 567

M 50503067 *
A 50503267 *

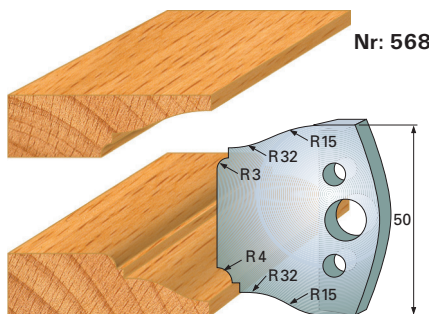

Nr: 568

M 50503068 *
A 50503268 *

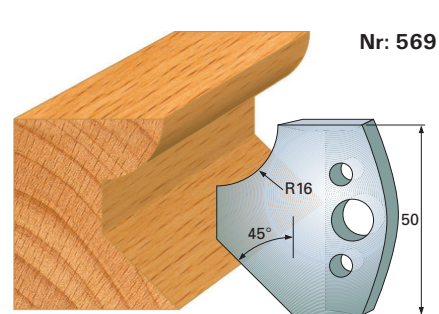

Nr: 569

M 50503069 *
A 50503269 *

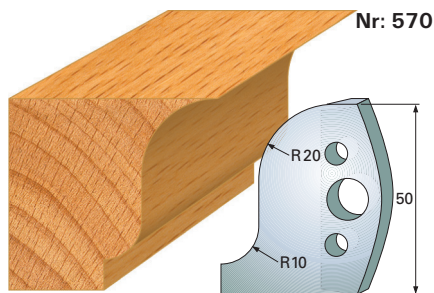

Nr: 570

M 50503070 *
A 50503270 *

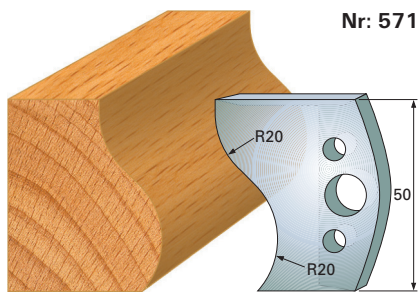

Nr: 571

M 50503071 *
A 50503271 *

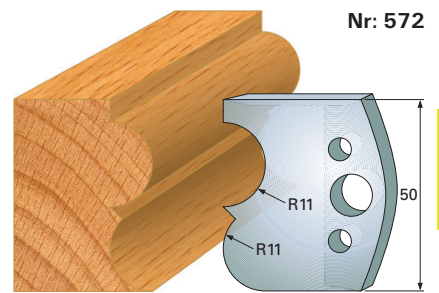

Nr: 572

M 50503072 *
A 50503272 *

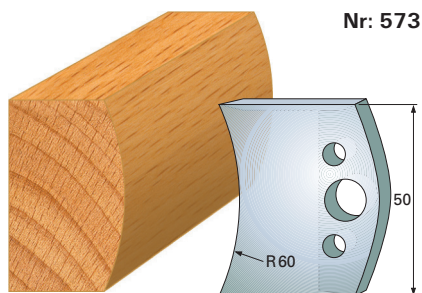

Nr: 573

M 50503073 *
A 50503273 *

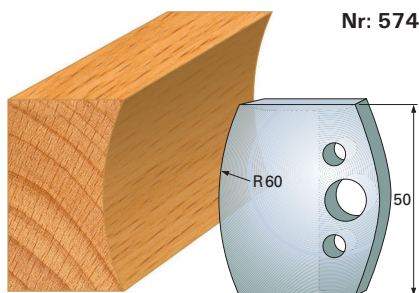

Nr: 574

M 50503074 *
A 50503274 *

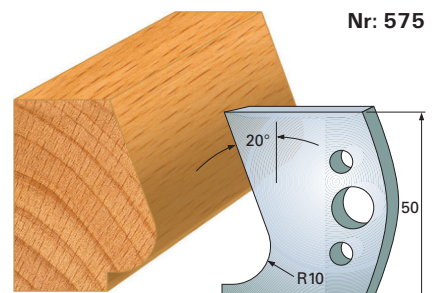

Nr: 575

M 50503075 *
A 50503275 *

M = Cuchillas perfiladas A = Deflectores *Modelo decontinado, hasta fin de existencias

Madera

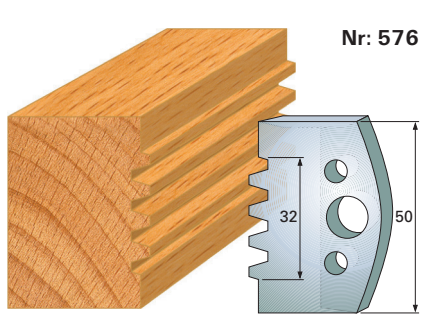

Nr: 576

M 50503076 *
A 50503276 *

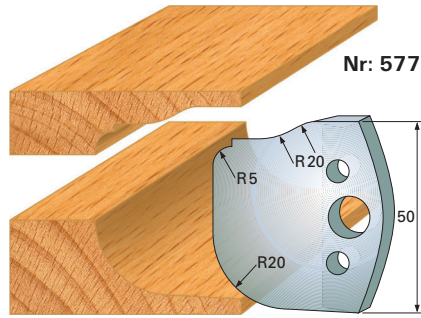

Nr: 577

M 50503077 *
A 50503277 *

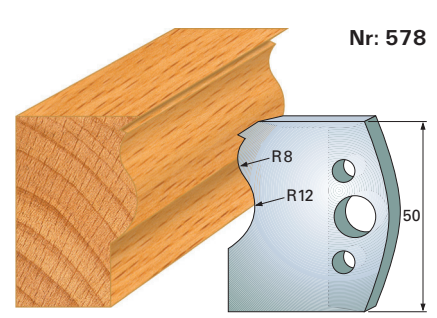

Nr: 578

M 50503078 *
A 50503278 *

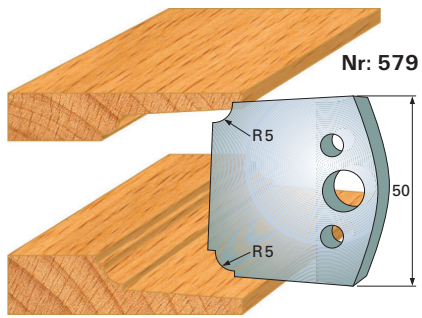

Nr: 579

M 50503079 *
A 50503279 *

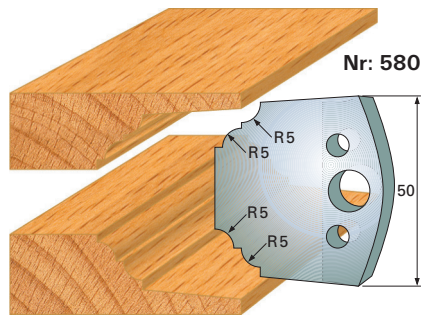

Nr: 580

M 50503080 *
A 50503280 *

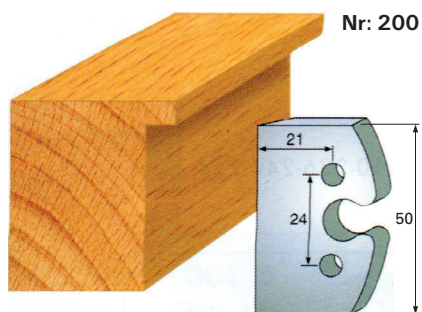

M 54030200 *
A 54032200 *

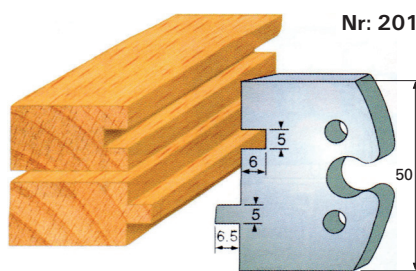

M 54030201 *
A 54032201 *

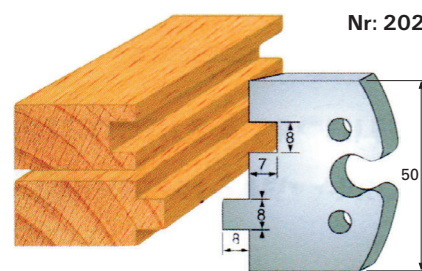

M 54030202 *
A 54032202 *

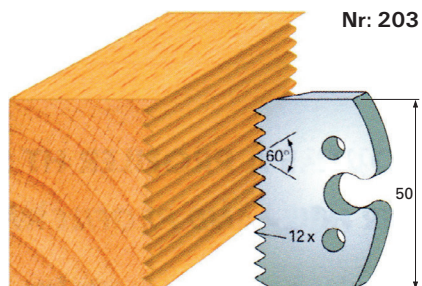

M 54030203 *
A 54032203 *

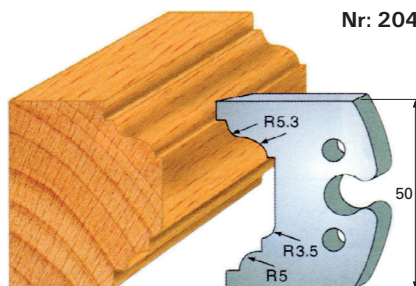

M 54030204 *
A 54032204 *

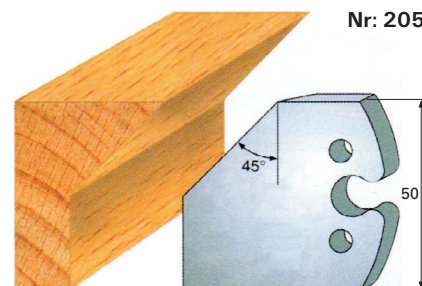

M 54030205 *
A 54032205 *

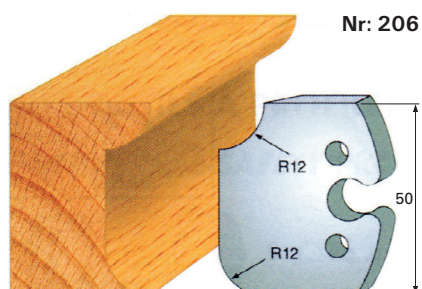

M 54030206 *
A 54032206 *

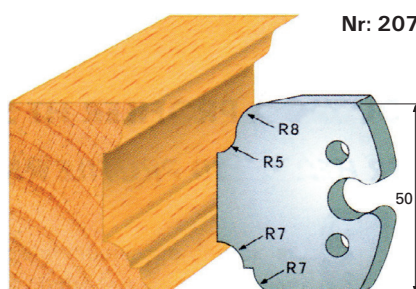

M 54030207 *
A 54032207 *

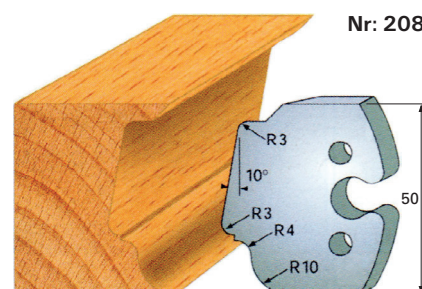

M 54030208 *
A 54032208 *

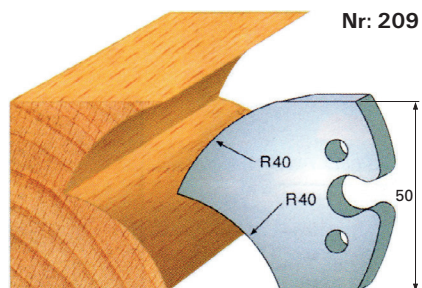

M 54030209 *
A 54032209 *

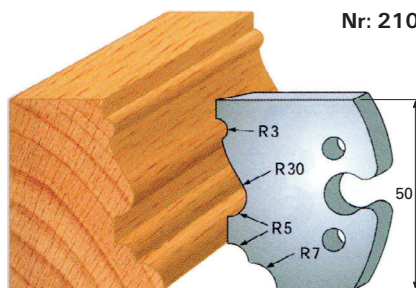

M 54030210 *
A 54032210 *

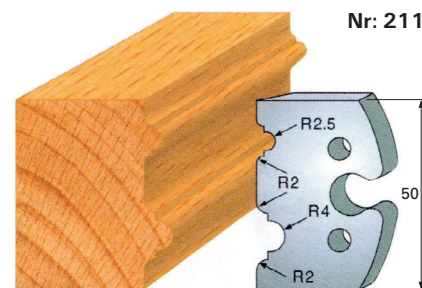

M 54030211 *
A 54032211 *

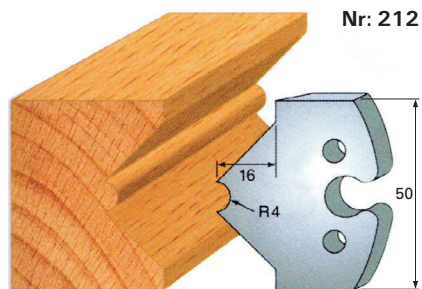

M 54030212 *
A 54032212 *

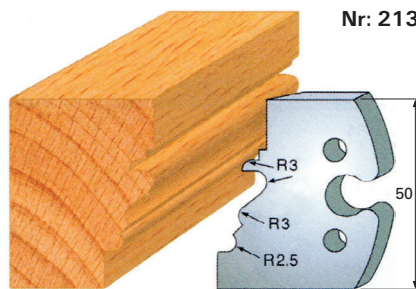

M 54030213 *
A 54032213 *

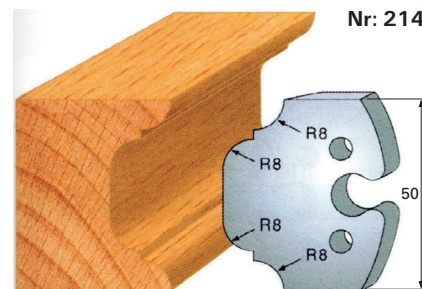

M 54030214 *
A 54032214 *

Madera

M = Cuchillas perfiladas A = Deflectores *Modelo decontinado, hasta fin de existencias

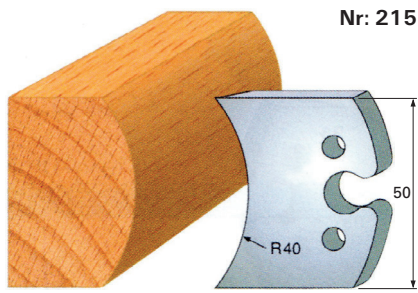

Nr: 215

M 54030215 *
A 54032215 *

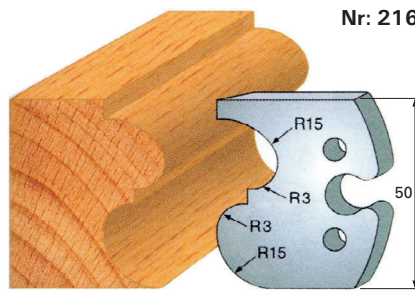

Nr: 216

M 54030216 *
A 54032216 *

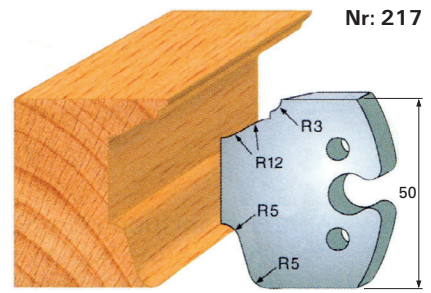

Nr: 217

M 54030217 *
A 54032217 *

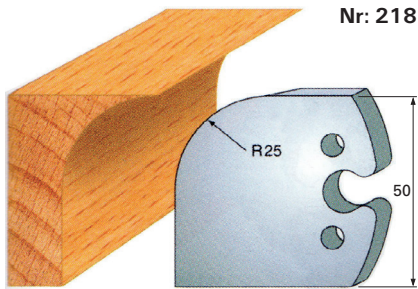

Nr: 218

M 54030218 *
A 54032218 *

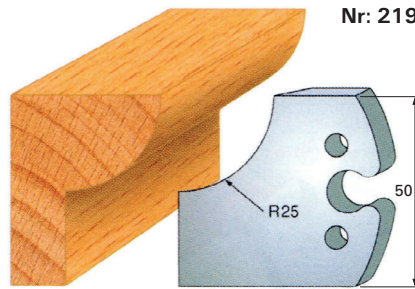

Nr: 219

M 54030219 *
A 54032219 *

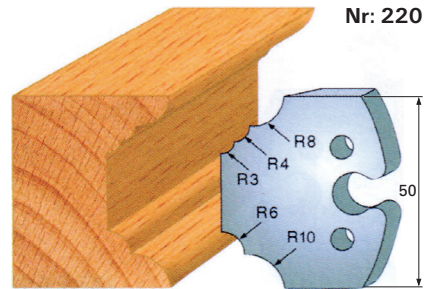

Nr: 220

M 54030220 *
A 54032220 *

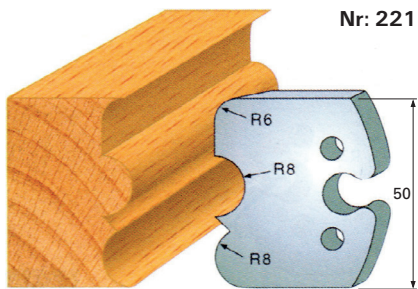

Nr: 221

M 54030221 *
A 54032221 *

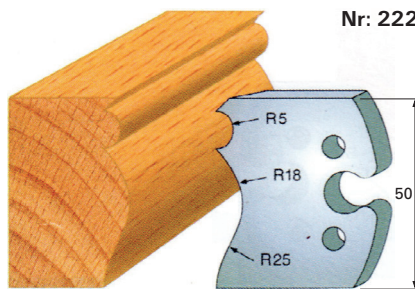

Nr: 222

M 54030222 *
A 54032222 *

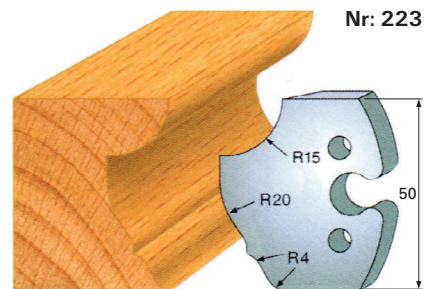

Nr: 223

M 54030223 *
A 54032223 *

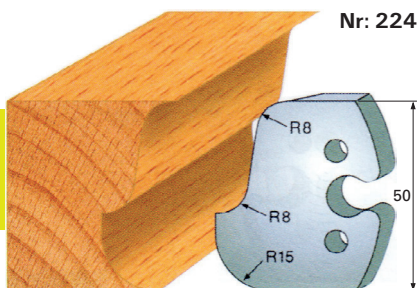

Nr: 224

M 54030224 *
A 54032224 *

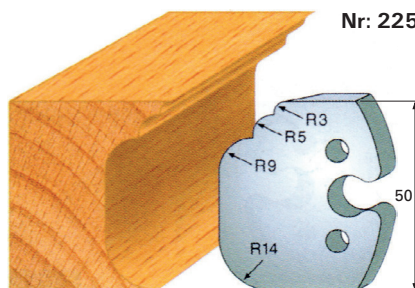

Nr: 225

M 54030225 *
A 54032225 *

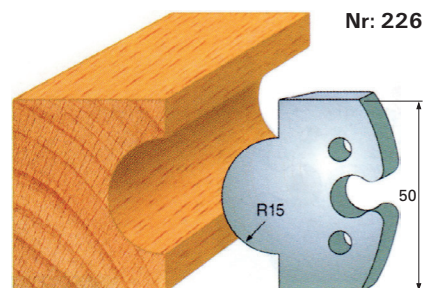

Nr: 226

M 54030226 *
A 54032226 *

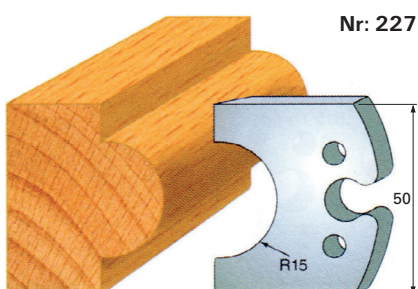

Nr: 227

M 54030227 *
A 54032227 *

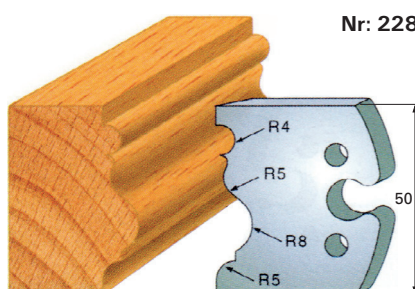

Nr: 228

M 54030228 *
A 54032228 *

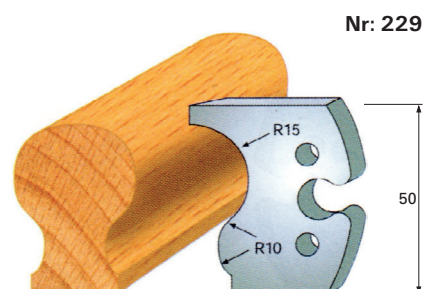

Nr: 229

M 54030229 *
A 54032229 *

Madera

M = Cuchillas perfiladas A = Deflectores *Modelo decontimado, hasta fin de existencias

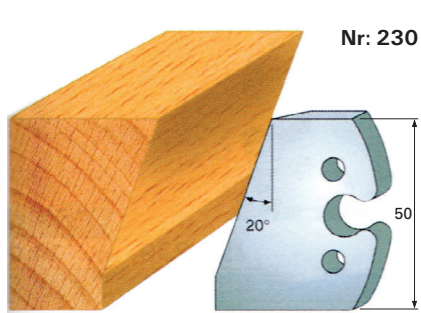

Nr: 230

M 54030230 *
A 54032230 *

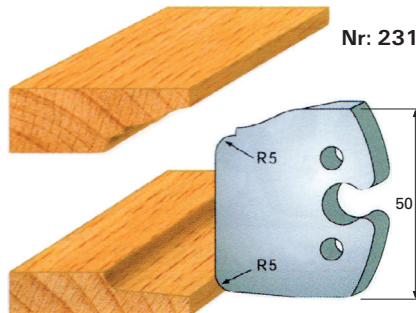

Nr: 231

M 54030231 *
A 54032231 *

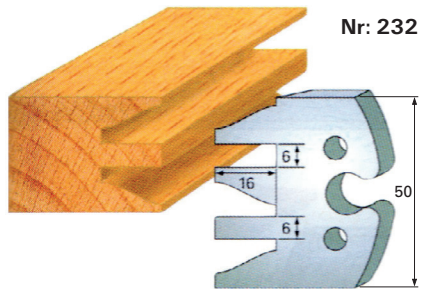

Nr: 232

M 54030232 *
A 54032232 *

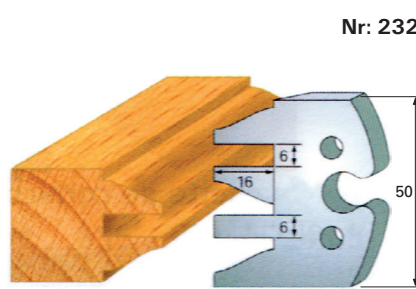

Nr: 232

M 54030232 *
A 54032232 *

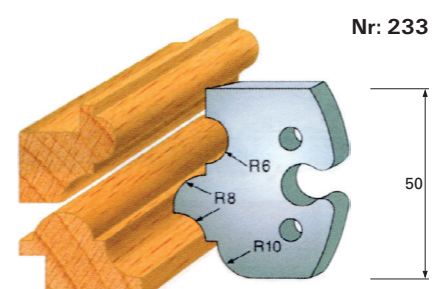

Nr: 233

M 54030233 *
A 54032233 *

HSS Cuchillas sin perfilar

VP = 6

Producto

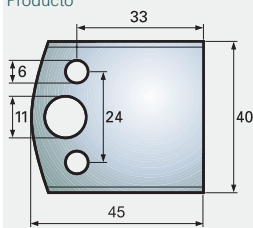

B= 40 mm

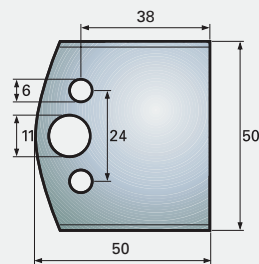

B= 50 mm

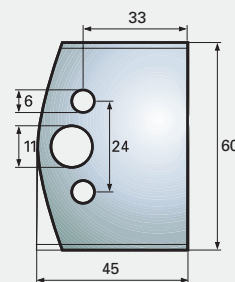

B= 60 mm

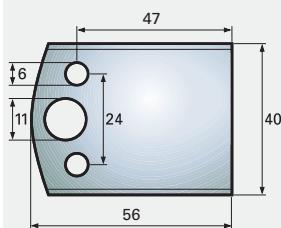

características del producto

B [mm]	L [mm]	d [mm]	Profundidad del perfil (T) max [mm]
40	45	4	19
40	59/56	4	30
50	50	4	24
50	59/56	4	30
60	45	4	19
60	59/56	4	30

Indicaciones

• Atención
Las cuchillas de nuestros cabezales Silverline deben rectificarse de 59 mm a 56 mm (debido al montaje estándar MAN).

Informaciones referente a su pedido

VP [St.]	número de artículo
6	40304045
6	40304059
6	40305050 *
6	40305059
6	40306045 *
6	40306059

M = Cuchillas perfiladas A = Deflectores *Modelo decontinado, hasta fin de existencias



Su distribuidor especializado:

